



*Temelsan*®

## KN-120-HBA-PLC BUTT WELDING MACHINE USER MANUAL



Congratulation to your new TEMELSAN Butt Welding Machine KN-120-HBA  
PLC

**INDEX**

<b>BASIC INFORMATIONS</b> .....	2
<b>APPROPRIATE USE</b> .....	2
<b>WARRANTY AND LIABILITY</b> .....	3
<b>SAFETY</b> .....	3
<b>QUALIFIED PERSONNEL</b> .....	3
<b>PLANNING AND SET-UP</b> .....	3
<b>OPERATIONS</b> .....	3
<b>SAFETY DEVICES</b> .....	3
<b>AREAS OF USAGE</b> .....	3
<b>MAINTENANCE</b> .....	5
<b>ISSUES</b>	
<b>SAFETY MEASURES RELATED WITH THE MACHINE</b> .....	6
<b>TRANSPORTATION - STORAGE - PACKAGING</b> .....	7
<b>STANDARD ACCESSORIES</b> .....	9
<b>OPTIONAL ACCESSORIES</b> .....	9
<b>REQUIREMENTS OF WORKING PLACE</b> .....	9
<b>FIRST CONNECTIONS</b> .....	10
<b>CONNECTION OF LIQUID COOLING (OPTIONAL DEVICE)</b> .....	10
<b>POWER SUPPLY (WIRING DRAW SEE AT FOLLOWING PAGE)</b> .....	12
<b>PRESS-AIR REQUIREMENTS</b> .....	14
<b>FIRST INSTALLATION AND ADJUSTMENTS</b> .....	16
<b>FIRST CLEANING</b> .....	16
<b>OPERATOR PANEL AND STARTING OF THE MACHINE</b> .....	17
<b>JAW LEVEL CALIBRATION (CLAMPING JAW ANNEALING PRESSURE POINT)</b> .....	38
<b>CLAMPING JAW CALIBRATION BY CARBON PAPER</b> .....	43
<b>SYSTEM DRAWINGS:</b> .....	45
<b>SPARE PART DRAWINGS</b> .....	59

## BASIC INFORMATIONS

This manual user guide is prepared to be useful in order to get familiar with the machine and the functions of the machine. By the help of this manual guide, the operator becomes a capable to use the machine in an optimal way in order to operationalize safely, ergonomically and properly.

This manual user guide allows the operators not to take risk, minimize the idle and repair time. It also helps to increase lifetime of the machine.

This manual user guide should be kept in a proper place and be accessible easily when needed. The local regulations included safety and environmental requirements must be followed in addition to the statements based on this manual user guide.

In case of an issue, complaint, request, demand on spare parts etc. please note the following information along with the below message

### **Concerning following Object:**

**Machine Model:** TEMELSAN KN-120-HBA PLC

**Mfg. year:** 2020

**Serial Number:** \_\_\_\_\_

### **APPROPRIATE USE**

The welding capacity for Band Saw Blades is from minimum 27x0.90mm up to a maximum 120 x1.60mm. The machine is capable to weld all kinds of band saw blades which are called carbon, wood, bi-metal, CT Work on the electrical power supply is only to be done by professional electrician.

In the event of using the machine rather than described in which case the machine would be out of warranty situation of Temelsan.

**Upset welding** /resistance butt welding is a welding technique that produces coalescence simultaneously over the entire area of abutting surfaces or progressively along a joint, by the heat obtained from resistance to electric current through the area where those surfaces are in contact. Pressure is applied before heating is started and is maintained throughout the heating period. The equipment used for upset welding is very similar to that used for flash welding.

**Flash welding** is a type of resistance welding that does not use any filler metals. The pieces of metal to be welded are set apart at a predetermined distance based on material thickness, material composition, and desired properties of the finished weld. Current is applied to the metal, and the gap between the two pieces creates resistance and produces the arc required to melt the metal. Once the pieces of metal reach the proper temperature, they are pressed together, effectively forging them together. You will be faced with technical words like Upset Pressure, Weld-Space, Welding-Ready Position. This will be explained later in this Manual.

(Some Text here is copied from Wikipedia, which explains very well the Butt Welding procedure, many thanks to the writer)

## **WARRANTY AND LIABILITY**

In the event of involving a personal injury or physical damages are not covered by the warranty if the following events occur as below.

- Using the machine for a purpose rather than intended
- Technically, improper installation, start-up operation or maintenance of the machine
- In the act of using the machine while any of safety equipment is a broken or protective device inappropriately running.
- Making constructional changes on running parameters.
- Insufficient control of abrasion parts
- Inappropriate repairs
- The catastrophic failures due to the action of foreign objects / Bodies and excessive force applied

## **SAFETY**

Below safety requirements must be applied without skipping anything and priority case to carry out.

## **QUALIFIED PERSONNEL**

Certain tasks must be carried out on the machine by a professional qualified personnel. Not third parties neither the children should be near the machine working area.

## **PLANNING AND SET-UP**

Planning, transportation, installation, programming, start-up, maintenance, repairs and other works must be done by qualified personnel. Authorized technician must check it also.

The following matters must be noted:

- Technical data and details concerning the permissible use of the machine and its accessories.
- General and specific local preparation and safety measures.
- Personal usage and the use of general safety equipment must be related the norms.
- Especially listed on this manual guide but specifically not listed in the operating instructions that have been explicitly forbidden. Such as a handicapped to use the machine is such cases it is necessary to contact the manufacturing company.

## **OPERATIONS**

Dangers hidden in disregards of safety regulations.

## **SAFETY DEVICES**

The machine is equipped with the safety devices corresponding to current state of the art. In the matter of safety equipment, the machine may not be disabled, removed, dismantled, damaged. It applies in particular to:

- Safety switches (Emergency Stop Button)
- Electrical and electronic fuses

## **AREAS OF USAGE**

---

TEMELSAN MAKİNA SAN. VE TİC. LTD. ŞTİ.

Akçaburgaz Mah. Muhsin Yazıcıoğlu Cad. No:55/1 Esenyurt / İstanbul / TÜRKİYE

TEL: +90 (212) 544-2518 FAX: +90 (212) 577-6557 [www.temelsan.com](http://www.temelsan.com) [temelsan@temelsan.com](mailto:temelsan@temelsan.com)



The butt-welding machine Temelsan KN120-HBA PLC is used for low-alloyed and high-alloyed steel bands and band saw blades or bi-metal or carbide tipped band saw blades.

The welding capacity for Band Saw Blades is from minimum 27x0.90mm up to a maximum 120 x1.60mm. The machine is capable to weld all kinds of band saw blades which are called carbon, wood, bi-metal, CT Work on the electrical power supply is only to be done by professional electrician.

The machine is a single piece and no need to be assembled.

The machine can be set-up by the customer's own staff if officially approved by Temelsan.

Please read the following sections thoroughly and carefully before the initial start-up and ensure that you clearly understand it.

## **MAINTENANCE**

In order to insure a safe operation on the machine and prevent accidents, the job listed in the section "Servicing" must be carried out regularly. If the owner of machine is not in a position to do that also must be arranged by an authorized service agent.

## **ISSUES**

The machine must be switched off at once in case of any problem occurs during the operation and then locked for not being restarted accidentally by an unauthorized person.

The machine must be switched off in this case.

- Unusual sounds, vibrations, smells
- Unusual operations on the monitoring device
- Increased temperatures or power consumption
- Unusual reaction during the manual or automatic operation
- Strange behavior and error messages displayed



### **WARNING!**

Only suitably qualified personnel must service the machine!



### **EMERGENCY**

## **ATTENTION!**

TEMELSAN MAKİNA SAN. VE TİC. LTD. ŞTİ.

Akçaburgaz Mah. Muhsin Yazıcıoğlu Cad. No:55/1 Esenyurt / İstanbul / TÜRKİYE

TEL: +90 (212) 544-2518 FAX: +90 (212) 577-6557 [www.temelsan.com](http://www.temelsan.com) [temelsan@temelsan.com](mailto:temelsan@temelsan.com)

Note the following at emergent cases (fire, water, explosions, breakage):

- Cut the machine off from the mains power supply at an external main switch or external fuses
- Switch off the compressed air supply
- Use the fire extinguishers of a suitable type to deal with the fire

## SAFETY MEASURED RELATED WITH THE MACHINE



### WEAR PROTECTIVE GLASSES!

Welding beads produced during welding work could damage your eyes.



### WEAR GLOVES!

The sharp edges of the blades can cause hand injuries.



### DANGER OF FIRE!

Easily inflammable materials could be set alight if they come in to contact with welding sparks. Kind of inflammable materials should keep far away from welding area constantly during the operation!



### SWITCH OFF THE MACHINE!

Cut off machine from the main supply before carrying out setting-up maintenance and servicing work on the machine.



### DANGER OF BEING CRUSHED!

There is a degree of danger if being crushed when in the proximity of the clamping jaws during inserting parts. There is a degree of danger being crushed between the clamping jaws during the setting-up operations.



### ATTENTION!

It's dangerous when contacting parts of the power supply, control and transformer.



### IN CASE OF EMERGENCY;

Push the emergency stop button.

The emergency stop button is to use by emergency issues only!

## TRANSPORTATION - STORAGE - PACKAGING

The machine may not be handled with special care in transport so as to prevent damage from impacts to careless loading and unloading. The measures listed below are essential. The following measures that must be taken only cover the transport within the company. Road, rail, airline transport and sea transport require additional measures to be taken.

Transport in assembled state (see figure below)

- Use only the lifting eyelets for transport by crane (Picture below)

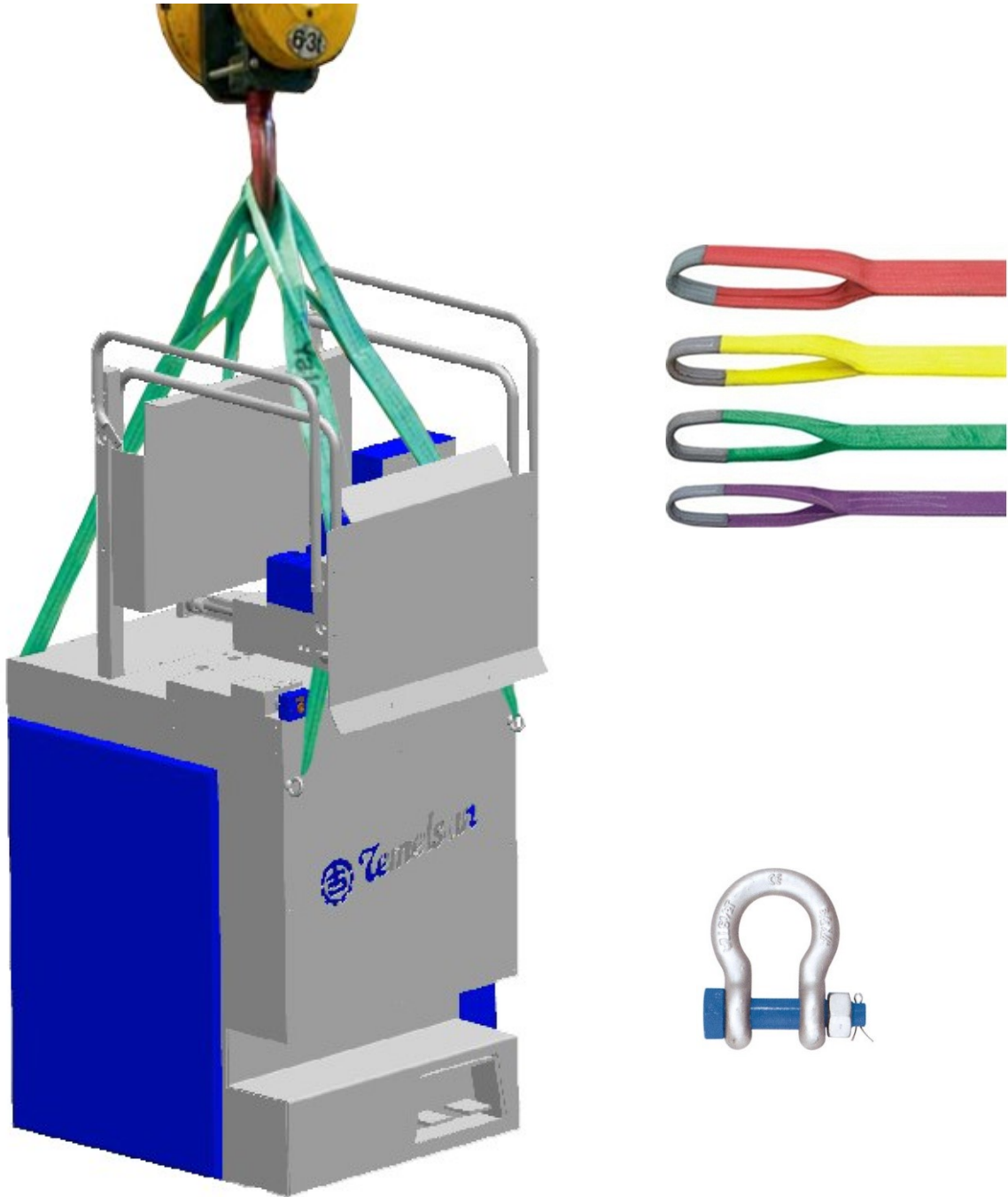

- The use by forklift (pictured blow)



**Attention: RISK OF TIPPING OVER**

**The higher center of gravity requires a special view for transportation even the Machine should be fixed by screws to the pallet.**

**STANDART ACCESSORIES**

500 Bar	Strong Hydro-Pneumatic clamping system
27-120mm	Width Bi-Metal and CT-Band welding capacity
30-120mm	Width Wood-Band welding capacity (by additional jaws 70mm width)
One type jaws	Both side usable and turn able for small widths
Adjustable	Numeric stoppers for cambered band saw blades
Digital Display	With touch-screen control
400 Logs	For 400 different of band saw blade dimensions.
High Pressure Air	Cleaning system (air blow off), nozzles positioned inside the clamping jaws
Full Auto Annealing	Control by pyrometer 300-1300oC, swing system, measuring area 4x4mm
Pyrometer Cover	Is a well-constructed metal box with fully automatic open and close functionality; switch controlled, includes also the LED working place lamp. Digital positioning system of clamping jaws.
Air Pistol	For manual cleaning
Air Reservoir	To combine the income air capacity
Support Tools	Pre-Adjustment tools

**OPTIONAL ACCESSORIES**

Barcode Reader

Liquid	Cooling System
Flash (Spark)	protection cover with auto start-stop
High precision	De-Burring system
2 Set Spare	Upper and Lower Jaws (4 pcs of upper + 4 pcs of lower jaws)

Please check the Packing when arrived before unloading the machine from truck.

Do not accept the delivery if packaging is damaged or broken by transportation.

In case of broken or damaged packing of machine, it's possible with agreement of Transportation Company to unpack and check the machine condition before down loading

As soon you unload the machine, you accept the condition of machine, you take any responsibility for damages and eventually repairs.

**REQUIREMENTS OF WORKING PLACE**

- Flat and smooth ground
- Required big enough area around the machine
- Environmental conditions
- The running of the machine is not permitted if flammable liquids and objects are near to welding machine
- Enough air circulation is required
- The client is obliged to local electrical distributor notified technical requirements

## RECOMMENDATION HOW TO PLACE THE TEMELSAN KN120HBA-TOUCH MACHINE

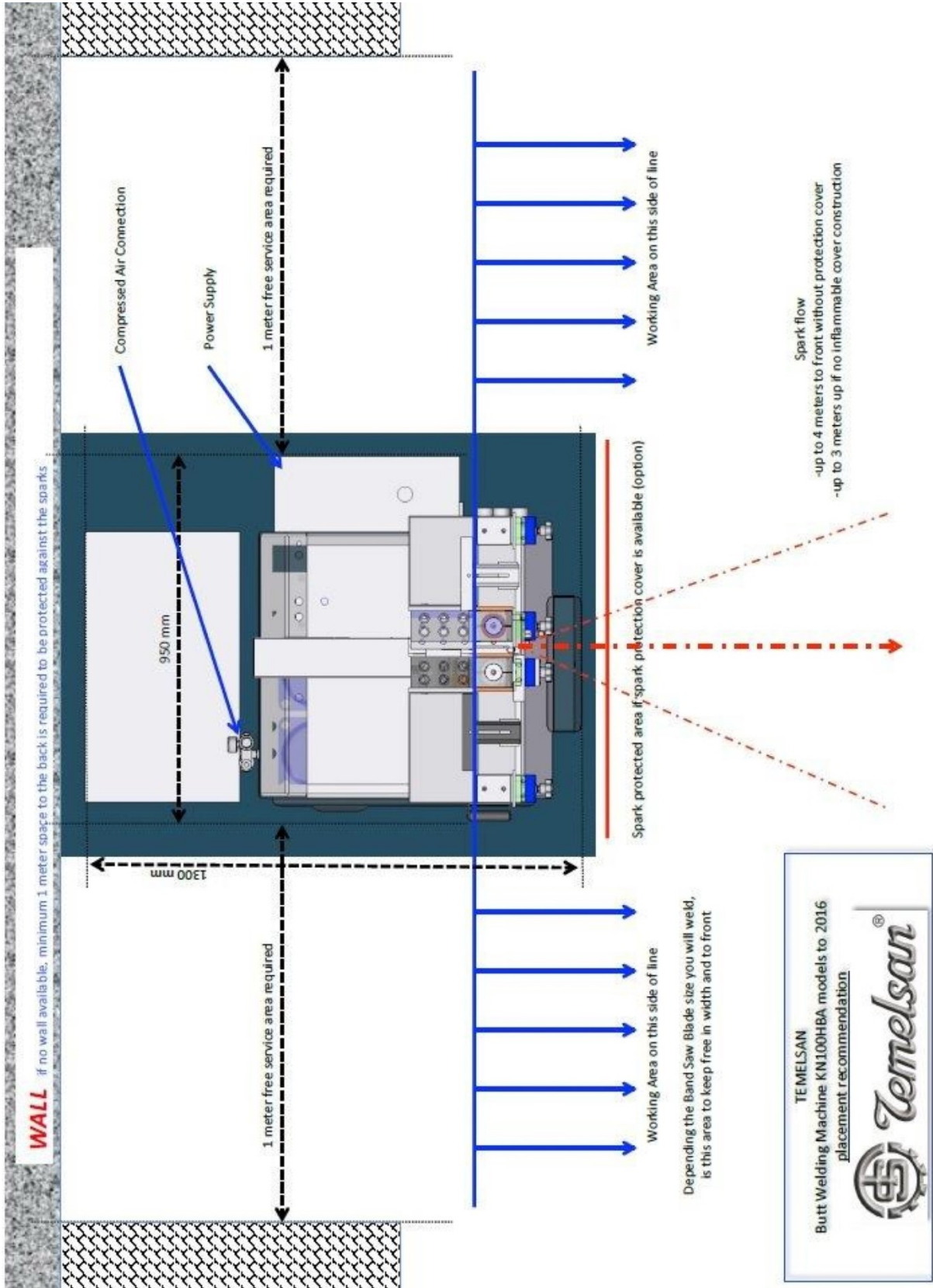



The Jaws and the transformer are heating up after any weld and annealing procedure. Depends the number of welds and annealing during a short period and depends size of the band saw blades is the cooling time too short, the jaws and there level adjustment getting deformation and adjustment changes.

The cooling system is an separate liquid cooling system which is to position on the back of the welding machine. The liquid is an simple antifreeze pure which is used for cars. Do not use Alcohol.

The supplied Tubes have to be connected to the shot-off valves right behind the Machine and the valves have to be opened. Make sure you fill antifreeze liquid to the maximum level after connecting to welding machine and running the cooling system few minutes.

Also behind the welding machine is located an 220V plug where the cooling system have to be plugged. The 220V plug will supply power only when main power switch of welding machine is switched on, additionally the cooling system has an on/off switch.

The liquid temperature is adjustable down to 9-10°C, very important to know that the adjusted temperature should have not more then 10°C temperature different to room/working place air temperature. For example; if Room temperature is 25°C, the cooler should be adjusted not less then 15°C.

The reason is to prevent condensation of jaw blocks and transformer body. **We recommend to adjust the cooling system with 20°C**

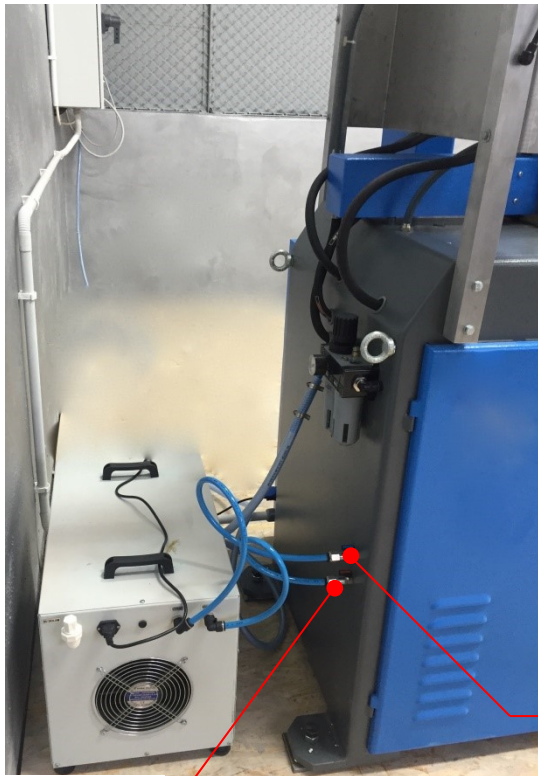

LIQUID IN

LIQUID OUT



**Plug it in just behind the Welding machine.**



**POWER SUPPLY (Wiring draw see at following page)**

**Make sure that the main switch of the machine is on OFF position and prevent to be turned on by an accident.**

A qualified electrician must do the connection.

The input voltage (standard norm) is 400V AC (3 Phase + Neutral + Ground) 50Hz.

The input voltage (US Norm) is 600 V AC (3 phase + Neutral + Ground) 60 Hz. (optional)

The recommended fusing for power supply is **63 Amp fuse, sluggish type**

**The Diameter of each wire for power supply it's very important, please use the chart by selecting the Machine Type**

**Do not switch ON the machine before the all setup instruction is read and work performed**



**ATTENTION!**

Pay special attention to protect yourself from the energized cables moreover the control panel while operating the machine. Keep closed the cover of electrical control panel and do not forget to take out all the foreign objects in the cabinet which might cause short circuit.



**WARNING!**

- Working on the electrical power supply has to be only done by professional electrician.
- The electrical equipment of the machine must be checked regularly
- Always keep the switching cabinet locked. Access is only permitted to authorized personnel with the key or special tool.
- Remove at once any loose or worn cables
- If it is essential to work on parts carrying a current there must be a second person present to turn off the main switch in case of an emergency
- The customer is required to comply with the technical conditions and requirements of the relevant electrical power supply company

		KABLO / CABLE						
MAKİNE MODELİ MACHINE TYPE	TRAFO KVA	ŞEBEKE GERİLMİ LINE VOLTAGE	SİGORTA GEÇİKMELİ FUSE SLUGGISH TYPE	KABLO MODELİ CABLE TYPE	KABLO UZUNLUK CABLE LENGTH	NOMİNAL KESİT NOMİNAL CROSS SECTION	DİŞ ÇAP OVERALL DIAMETER	İLETKEN TEL SAYISI VE ÇAPI NUMBER OF CONDUCTING WIRE
		VOLT AC	AMPER		METER	mm <sup>2</sup>	mm	
KN41 HBS	4.5 KVA	400 VAC	50	TTR	< 5	5x10	21	6
KN67 HBS	12 KVA	400 VAC	63	NYN	< 5	3x16 + 10 +10	23	7x1,7
KN67 HBA	40 KVA	400 VAC	63	NYN	< 20	3x25 + 16+16	25	7x2
KN100 HBA	63 KVA	400 VAC	63	NYN	< 50	3x35 + 16+16	32	7x2,4

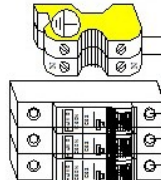

NYN

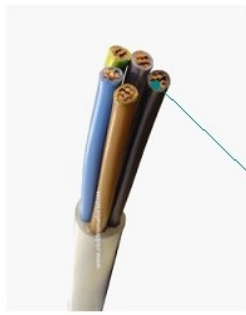

NYN

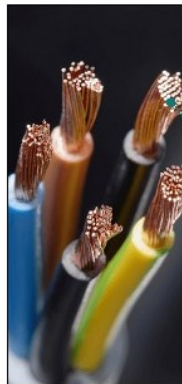

TTR

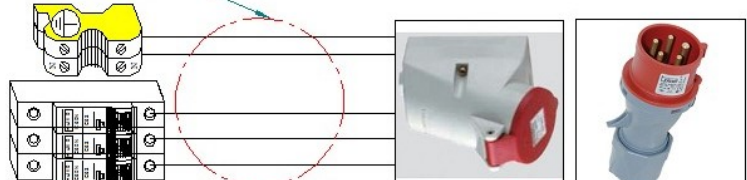

MAX 5 METER  
NYN 3X16+10+10  
(KN41 HBS TTR 5X10)

## PRESS-AIR REQUIREMENTS

The machine needs dry and clean air pressure, which needs 7-8 bars. The reservoir capacity of the air compressor should be 300-500 liters

After some time the air becomes wet and dirty, then please clean the conditioner of air right behind the machine.

Connect air hose supply coming from the compressor through on main shot-off valve to the conditioner at the rear side of the machine. We recommend to have positioned a shot-off valve on the escape route or behind the machine.

**As soon the compressed Air supply is connected, check and adjust the income pressure right behind the machine to 8 or maximum 9 Bar.**

**Machine has a Press-Air control-switch; it will give an Alarm when incoming air-pressure is too low. Following page shows an overview about Press-Air Connection.**

### Air Supply Check

Main Air Supply minimum 8 maximum 9 Bar

The compressor should be adjusted as starting to fill the air by 8 Bar and stop to fill by 9 Bar

If Clamping Pressure does not reach the 400 Bar, the main air pressure is too low never adjust the main Air pressure over 10 Bar. Factory adjustment is 8 Bar the Tube size for Air Pressure supply is minimum 12x10 mm.

Machine can weld the smaller bandwidths by lower Air pressure but the wider bandwidths could be not welded well. In fact you limit your machine if you use low air pressure supply. Machine needs always higher Air-Pressure income then finale for Bandwidth needed.

### Table for Air pressure comparison to clamping pressure KN-120-HBA

Income Air Pressure	Created Clamping Pressure	Required Bandwidth	Clamping Pressure
5 Bar	340 Bar	27mm	300 Bar
6 Bar	420 Bar	34mm	350 Bar
6,5 Bar	500 Bar	41mm	400 Bar
7 Bar	580 Bar	54mm	450 Bar
		67mm	450 Bar
		80mm	500 Bar
		100mm	500 Bar
		120mm	500 Bar

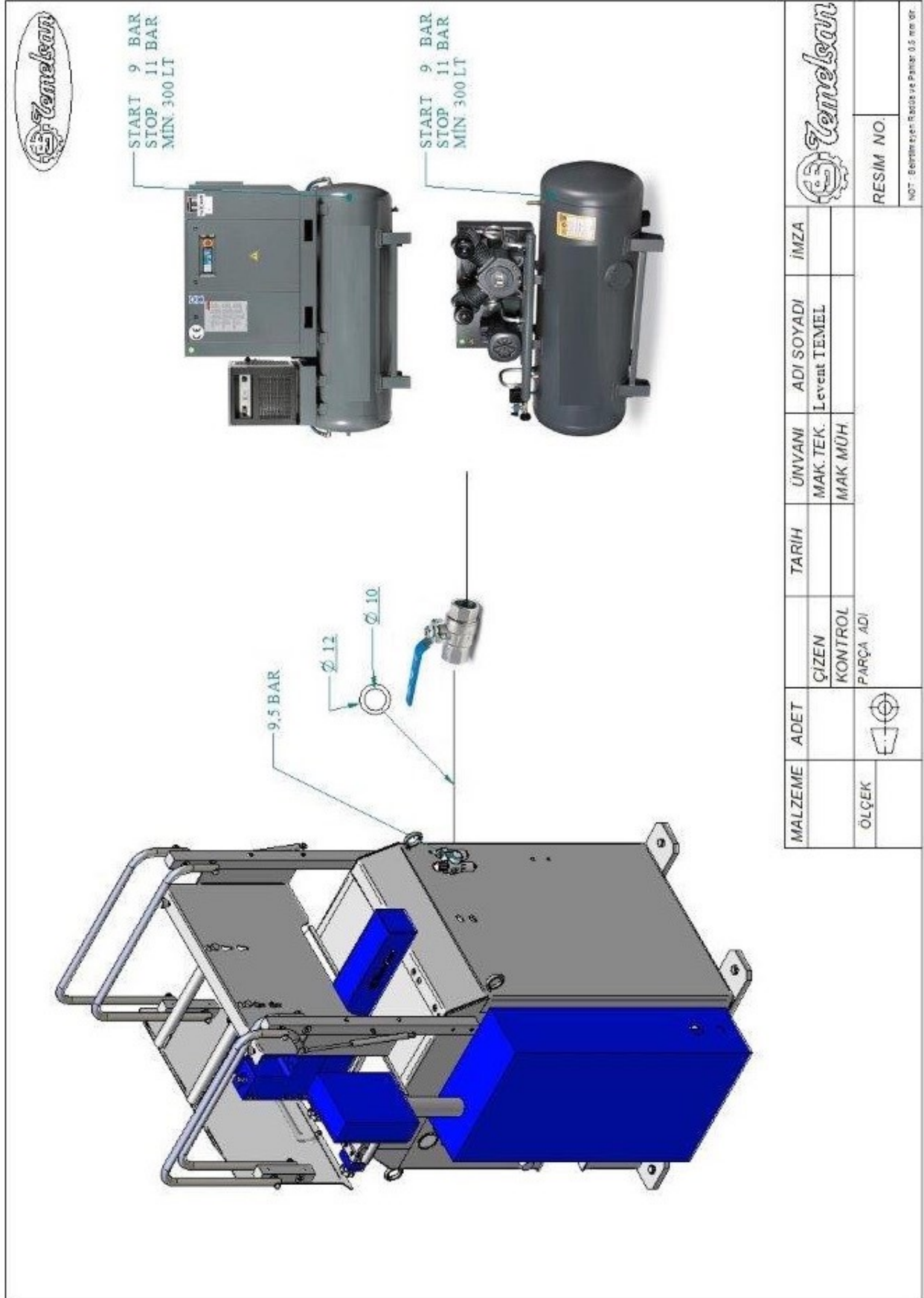

MALZEME		ADET	ÇİZEN	TARİH	UNVANI	ADI SOYADI	İMZA
ÖLÇEK			KONTROL		MAK. TEK.	Levent TEMEL	
			PARÇA ADI		MAK MÜH.		
							RESİM NO.
NOT: Benzeri için Rastis ve Pankop 0.5 no. dir.							

## FIRST INSTALLATION AND ADJUSTMENTS

Authorized professionals, who must read this user guide, must do first installation and adjustments. In case of questions, is an immediately contact with manufacturer/supplier required.

## FIRST CLEANING

Unpainted parts on the machine are slushed with conservation oil and have to be cleaned before the operation can start. Especially the jaws and around them must be cleaned properly.

### Check Points

1. Power is connected through the instructions above, All fuses are ON also inside the electro cabinet
2. Air is connected and adjusted with 8 Bar (KN 120 HBA touch)
3. Cooling System is connected properly (Optional device)
4. De-Burring System is available (Optional device)
5. Spark Protection Cover is available (Optional device)

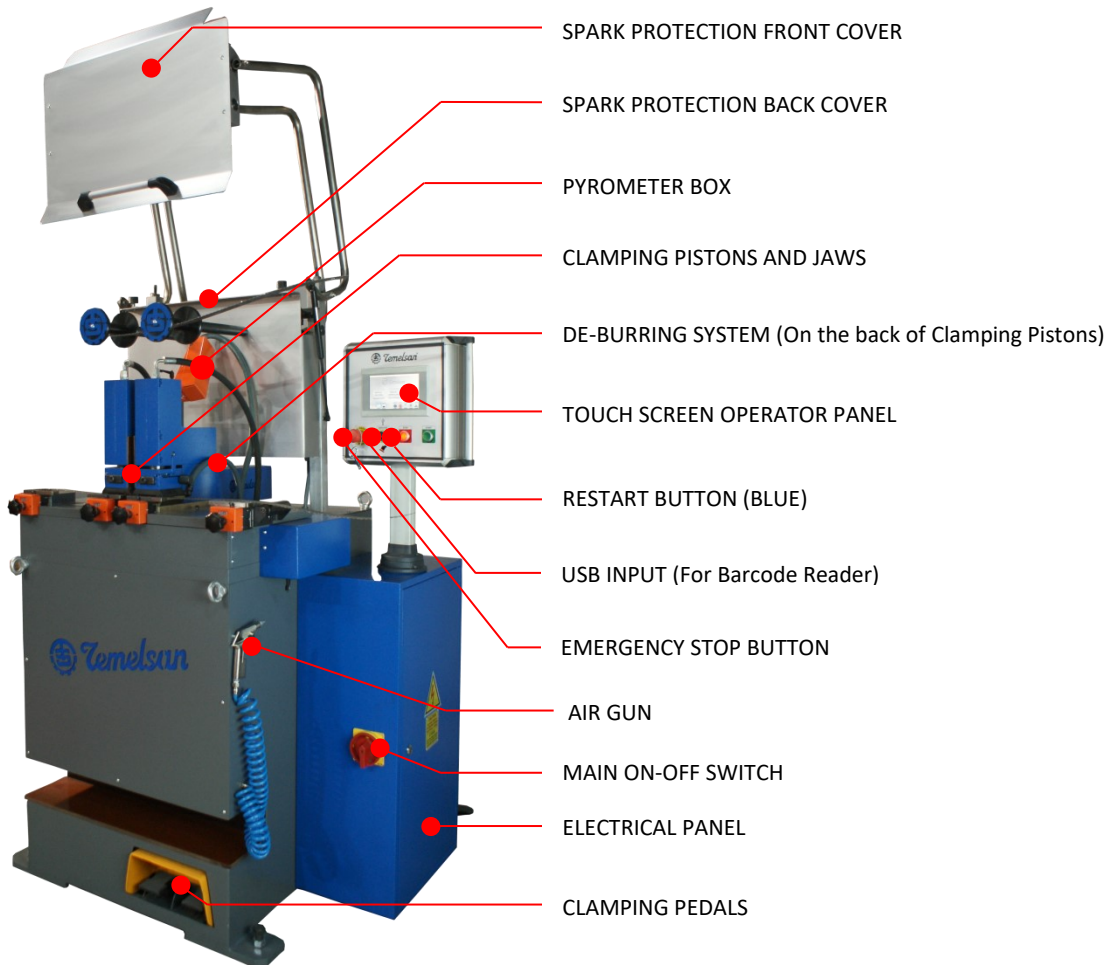



## OPERATOR PANEL AND STARTING OF THE MACHINE

The new type of KN 120 HBA PLC version has touch screen operator panel with optional barcode reader system. More easy and more specific settings of welding and annealing procedure can be done faster with touch screen panel.

The steps below should be followed for correct start of the machine.

- Switch the main ON-OFF switch to the ON position.
- Check and unlock the Emergency Stop Button (to unlock turn on Button to left side)
- Press and hold the BLUE RESTART BUTTON on the Operator panel for few seconds.

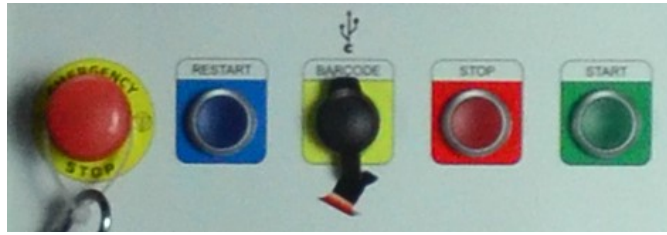

Then the machine starts to get its reference point automatically.

**CAUTION!** The machine gets its reference point every start. While machine is moving to get reference, please **DO NOT** touch any part of the machine.

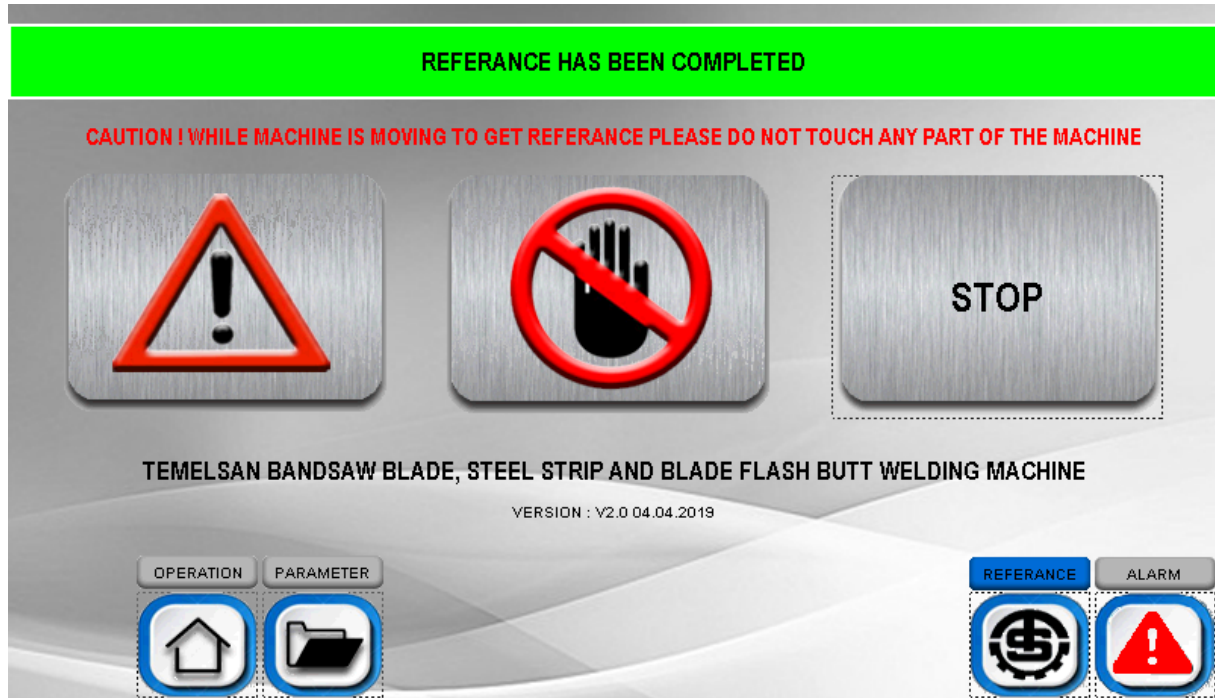

Green colored box with 'REFERANCE HAS BEEN COMPLETED' text indicates the reference is completed and the machine is ready to use.

**ATTENTION!**

Please contact the authorized Temelsan technic personnel if you receive an error as follows.

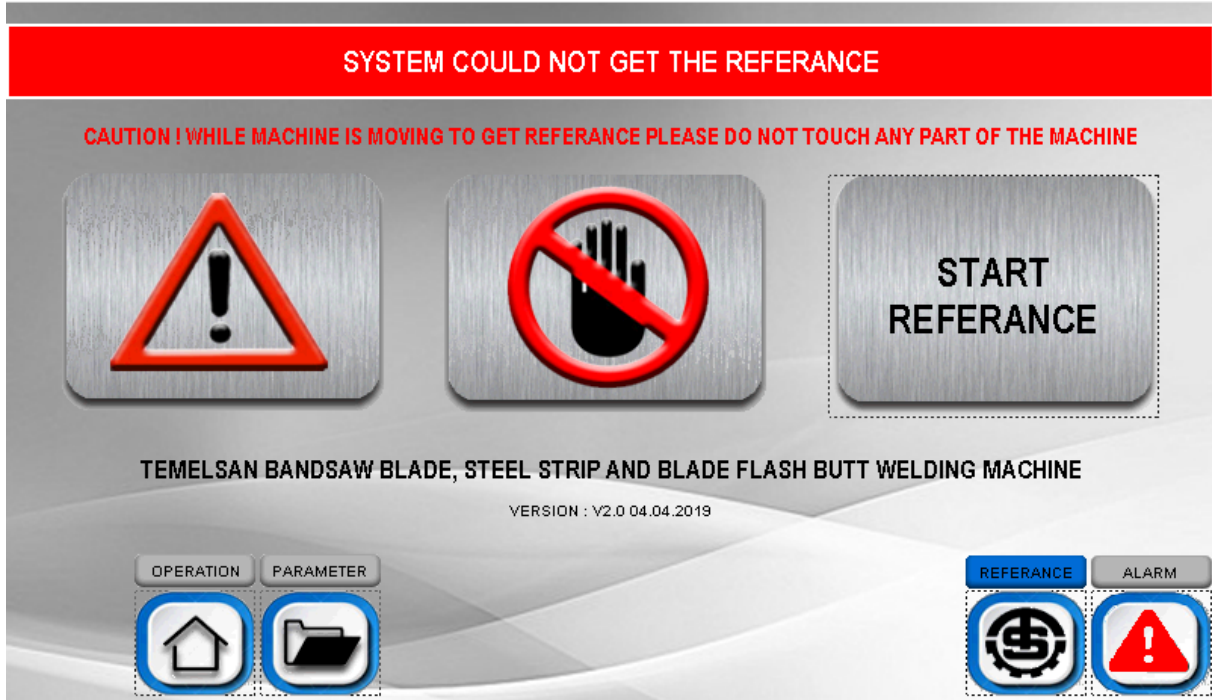

The main menu appears in the screen when the machine ready to use.





There are 3 options to choose;

- 1- **WELDING**
- 2- **ANNEALING**
- 3- **AUTOMATIC WELDING & ANNEALING**

## 1 - DESCRIPTIONS OF ONLY WELDING PROCESS



This process provides the desired welding with the parameters to be entered manually. The options below appear on the screen when user click Welding button.



The user can assign the value which want to change by simply clicking on it. When the user click on it, a numeric keypad appears shown like at below.

**Note:** The shown values indicate the minimum and maximum applicable value range. User should make selection within these values.

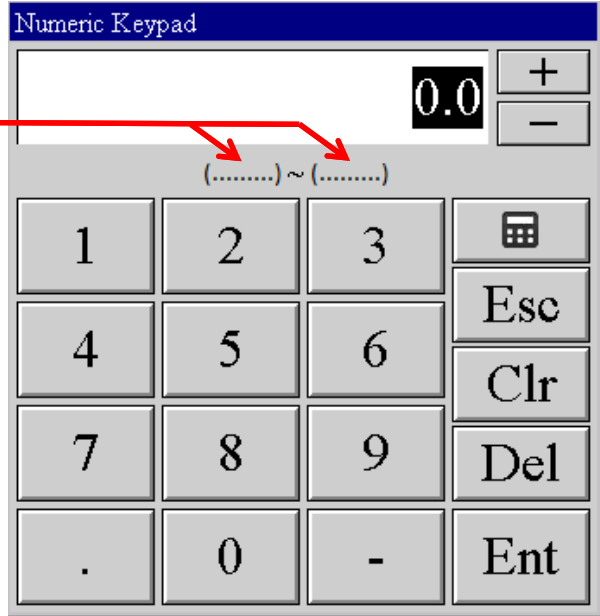

**Welding Current:** To set welding current as percentage. (0 - 99%) (\*Note: Welding Current is one of important setting for qualified welding.)

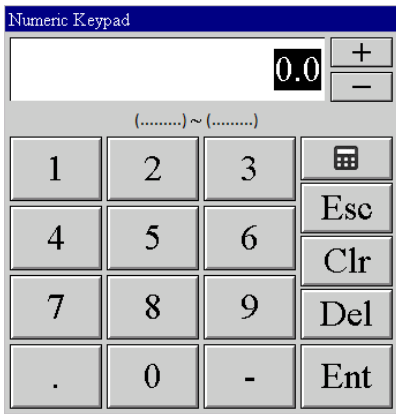

When this numeric keypad appears, user can assign the percentage of using the transformer.

After user assigned the percentage, user has to click “Ent” button to confirm it.

If user wants to cancel his/her changes, user should click the “Esc” button to cancel it.

If user needs to change assigned values his/her can use the “Clr” button to delete all numbers which is appear.

**Welding Speed:** To set welding speed as percentage. (0 - 99%)

After user clicks of this button, numeric keypad will be appear and user have to assign value there to set parameters.

This option is the speed of welding operation, but it must be kept within a certain minimum and maximum range, depending on saw characteristics and dimensions.

**Clamping Pressure:** To set clamping pressure which changes related to saw width and thickness as a pressure unit (bar).

**Jaw Gap:** The gap distance between left and right jaw which changes related to saw width and thickness as a millimeter.

**Welding Stop Point:** The point which finishes the welding process .The inputted value indicates the position of Cam of the machine as degree.

This option helps user to adjust his/her welding burr size and also this is one of important parameter of welding.

After user clicks of this button, numeric keypad will be appear and the user has to assign values to set parameters.

**Up-Set Pressure:** To set up-set pressure which changes related to saw width and thickness as a pressure unit (bar).

If all of above are set the desired values, click on the apply button and finalize the welding settings.

To start welding process, push the **GREEN START BUTTON** on the operator panel.

**Once the parameters have been assigned, the machine will recall those parameters until the user wants to change the parameters. In this way, the parameters do not need to be assigned each time.**



The right side of the screen shows the instantaneous values of Left Jaw Pressure, Right Jaw Pressure, Up-Set Pressure and Jaw Gap Distance.

When welding process is done, the following screen appears.



**Save Last Parameters:** Saves the last parameters which have been assigned settings on last welding. If welding quality is satisfying, the user can save welding parameters by this button.

**Repeat The Last Operation:** Reapplies the last parameters which have been assigned and switches the screen to the select operation screen.

**Select Operation:** If welding quality is not satisfying, the user can change welding parameters by this button. The parameters below appear on the screen when user touch Select Operation button. The user could change the values by clicking on it.



## 2 - DESCRIPTIONS OF ANNEALING SETTING SCREEN



When Annealing option selected, there are 2 options to choose which showed on the picture below.



If De-Burring Passive option selected, you have not change or set any value on the machine about de-burring. The screen appears which has values required for the annealing operation will be displayed directly.

If De-Burring active option selected, the screen has come to the screen mentioned below.

**CAUTION!**

**De-Burring Thickness have to be set manually to the correct value respect to the saw thickness. In case of set incorrect value, De-Burring unit and machine parts can be damaged critically.**

**For set the De-Burring thickness, click the "LAST DE-BURRING THICKNESS SET" and assign desired value.**

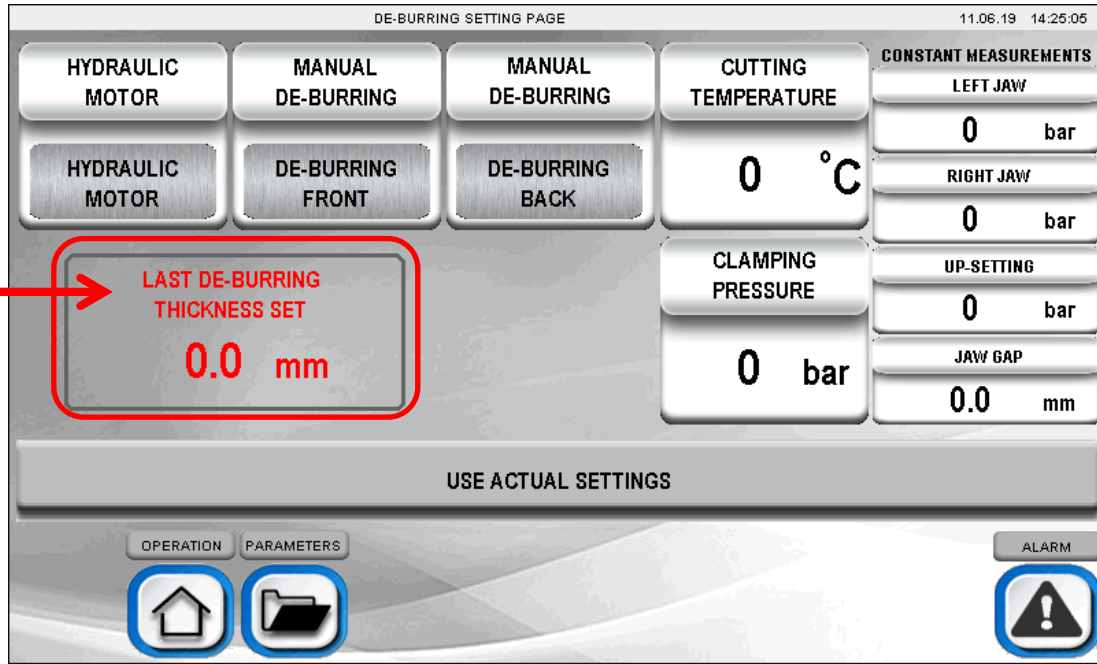

**Hydraulic Motor:** Starts the hydraulic motor which provides the necessary power for de burring. While De-Burring operation hydraulic motor have to be work. The user can start to work the motor by clicking on 'HYDRAULIC MOTOR' button.

**Manual De-Burring:** Moves the De-Burring unit to the front or back manually.

**Cutting Temperature:** Sets the temperature which desired temperature for De-Burring operation.

**Clamping Pressure:** Sets the clamping pressure for De-Burring operation.

**Constant Measurements:** Shows the instantaneous values of Left Jaw Pressure, Right Jaw Pressure, Up-Set Pressure and Jaw Gap Distance.

If all of above are set the desired values, move to set annealing settings click on the 'USE ACTUAL SETTINGS' button and finalize the De-Burring settings. When user clicks that button following screen appears.





ONLY ANNEALING SETTING PAGE 11.06.19 14:29:43

1st TEMPERATURE	2nd TEMPERATURE	3rd TEMPERATURE	CONSTANT MEASUREMENTS	
0 °C	0 °C	0 °C	LEFT JAW	0 bar
			RIGHT JAW	0 bar
1st TIME	2nd TIME	3rd TIME	CENTERING DISTANCE	UP-SETTING
0.0 sec	0.0 sec	0.0 sec	0.0 mm	0 bar
				JAW GAP
				0.0 mm

APPLY

OPERATION    PARAMETERS    ALARM

**1<sup>st</sup> Temperature:** Temperature value that to be reach of first step of annealing.

**2<sup>nd</sup> Temperature:** Temperature value that to be reach of second step of annealing.

**3<sup>rd</sup> Temperature:** Temperature value that to be reach of third step of annealing.

**1<sup>st</sup> Time:** Time value as seconds that to be apply first step of annealing.

**2<sup>nd</sup> Time:** Time value as seconds that to be apply second step of annealing.

**3<sup>rd</sup> Time:** Time value as seconds that to be apply third step of annealing.

**Centering Distance:** Distance between the jaws. (Welding line set in the center always.)

**Constant Measurements:** Shows the instantaneous values of Left Jaw Pressure, Right Jaw Pressure, Up-Set Pressure and Jaw Gap Distance.

If all of above are set the desired values, press on the apply button and finalize the annealing settings.

To start annealing and De-Burring process, push the **GREEN START BUTTON** on the operator panel.



### 3 - DESCRIPTIONS OF AUTOMATIC WELDING & ANNEALING SETTING SCREEN



This process provides the desired welding and annealing with the parameters to be automatically. The options screen at below shown on the screen when the user clicks on Automatic Welding & Annealing button.



### CREATING A NEW PROGRAM:

When user clicks 'CREATE A NEW PROGRAM' button following screen appears.

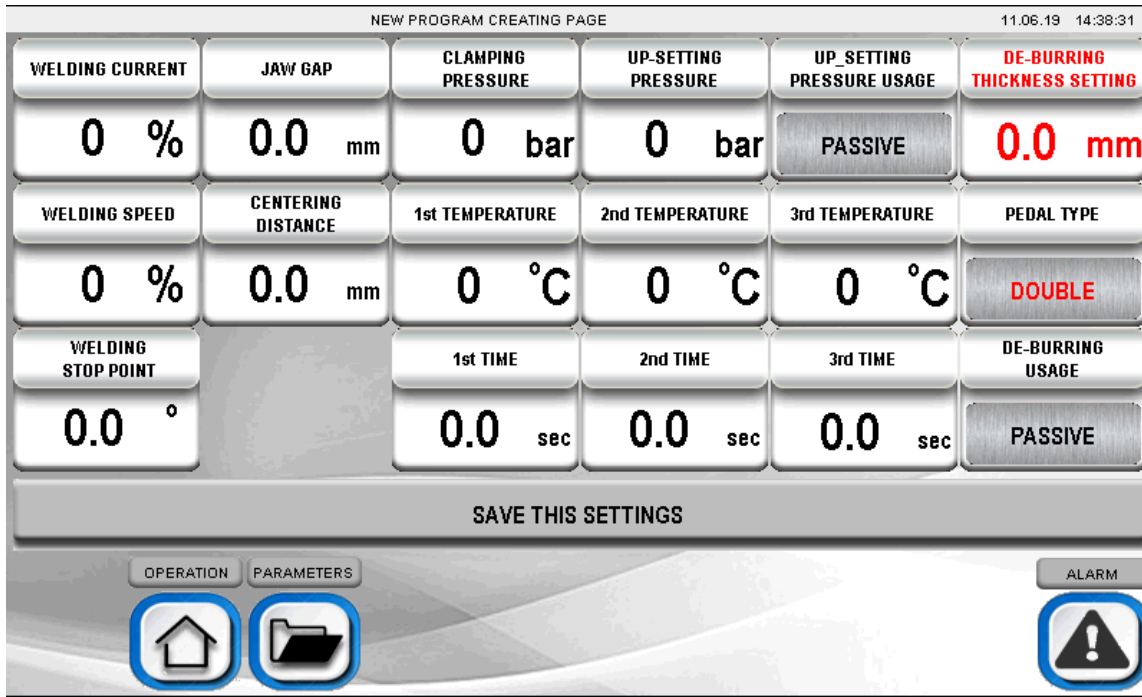

The user can assign the value which want to change by simply clicking on it. When the user click on it, a numeric keypad appears shown like at below.

**Welding Current:** To set welding current as percentage. (0 - 99%) (\*Note: Welding Current is one of important setting for qualified welding.)

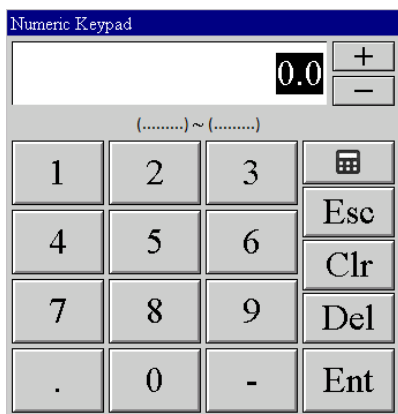

When this numeric keypad appears, user can assign the percentage of using the transformer.

After user assigned the percentage, user has to click "Ent" button to confirm it.

If user wants to cancel his/her changes, user should click the "Esc" button to cancel it.

If user needs to change assigned values his/her can use the "Clr" button to delete all numbers which is appear.

**Welding Speed:** To set welding speed as percentage. (0 - 99%) This option is the speed of welding operation, but it must be kept within a certain minimum and maximum range, depending on saw characteristics and dimensions.

**Clamping Pressure:** To set clamping pressure which changes related to saw width and thickness as a pressure unit (bar).

**Jaw Gap:** The gap distance between left and right jaw which changes related to saw width and thickness as a millimeter.

**Welding Stop Point:** The point which finishes the welding process .The inputted value indicates the position of Cam of the machine as degree.

**Up-Set Pressure:** To set up-set pressure which changes related to saw width and thickness as a pressure unit (bar).

**Centering Distance:** Distance between the jaws. (Welding line set in the center always.)

**1<sup>st</sup> Temperature:** Temperature value that to be reach of first step of annealing.

**2<sup>nd</sup> Temperature:** Temperature value that to be reach of second step of annealing.

**3<sup>rd</sup> Temperature:** Temperature value that to be reach of third step of annealing.

**1<sup>st</sup> Time:** Time value as seconds that to be apply first step of annealing.

**2<sup>nd</sup> Time:** Time value as seconds that to be apply second step of annealing.

**3<sup>rd</sup> Time:** Time value as seconds that to be apply third step of annealing.

**De-Burring Thickness Setting:** To set the De-Burring thickness to desired value.

**De-Burring Usage:** To set the De-Burring Unit Active or Passive.

**Pedal Type:** Single or Double Option

If all of above are set the desired values, press on the "SAVE THIS SETTINGS" button and finalize the settings. Then save details appears on the screen like picture below.

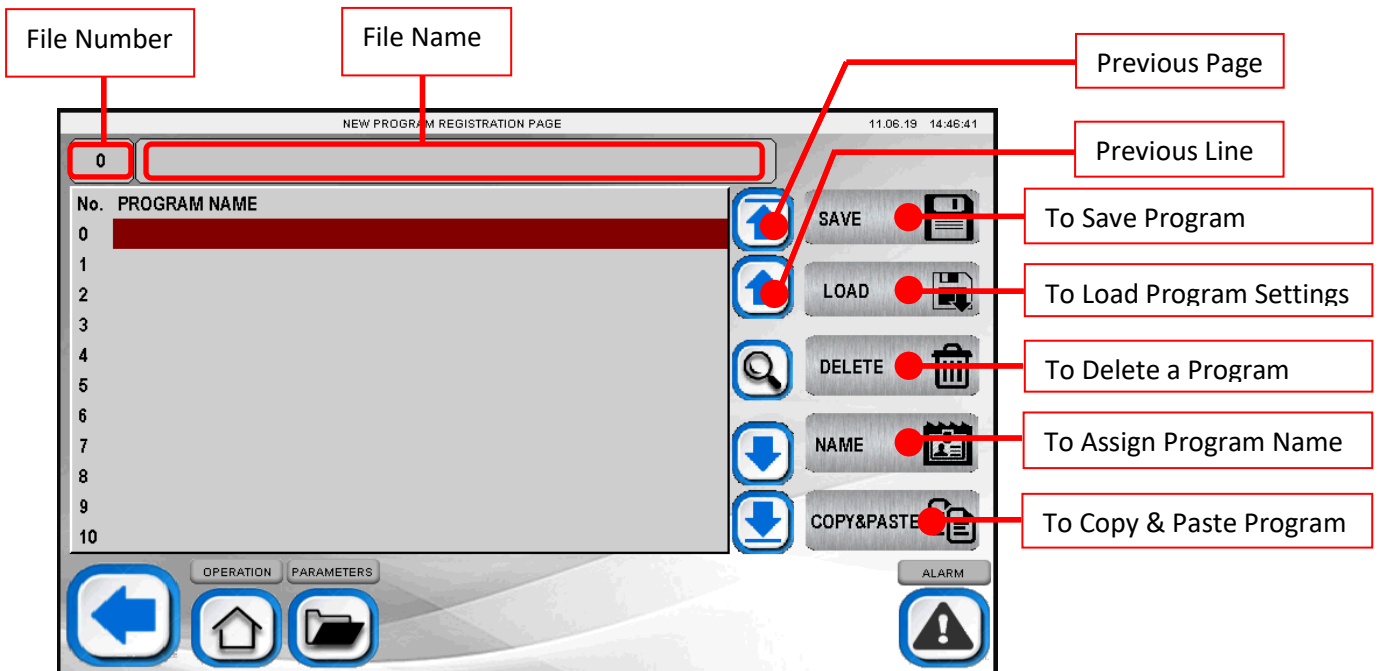

When user touched on the program name section a Keypad appears and the user could give desired name of your setting easily. Also the user can save the program to particular file number by clicking on the number which user wants to save.

Or

You could also use Barcode Reader for this step.

To finalize the creating a new program press the save button.

#### QUICK WAYS OF CREATING NEW PROGRAM:

- 1- Click the AUTOMATIC WELDING AND ANNEALING BUTTON
- 2- Click the NEW PROGRAME
- 3- Feed the necessary parameters.
- 4- Click RECEIPT button on right side below.
- 5- Click some empty area on list
- 6- Click the NAME button.
- 7- Write the name and click ENTER
- 8- Click the SAVE button
- 9- Click the LOAD button

Adding totally new program:

- 1- Please find the size which is closer to your new blade and load it to appear on screen.
- 2- Click RECEIPT button on right side below.
- 3- Click some empty area on list
- 4- Click the NAME button.
- 5- Write the name and click ENTER
- 6- Click the SAVE button
- 7- Click the LOAD button

After doing your tests about these parameters. When all quality is ok please follow instruction do not lose the parameters.

- 8- Click RECEIPT button
  - 9- Click SAVE button
- to save parameters with the exist name.

#### SELECT A PROGRAM FROM LIST:

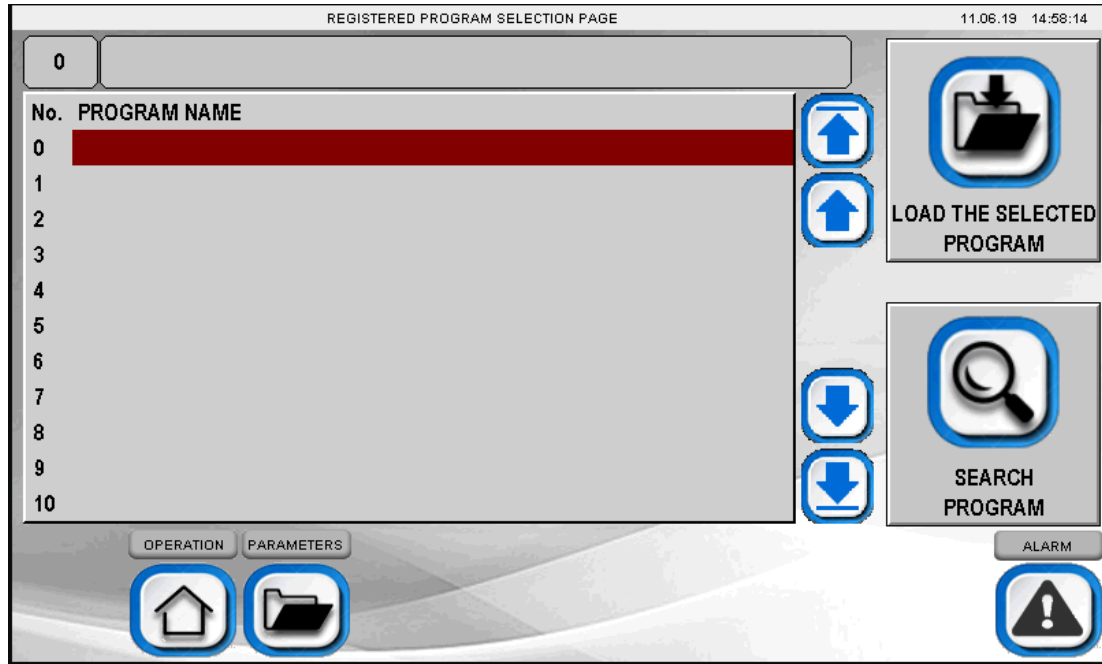

**Load the Selected Program:** To load welding and annealing properties that for selected saw properties which is set and saved before. When the user chooses a program and click 'LOAD THE SELECTED PROGRAM' button, assigned Welding & Annealing settings are set automatically and machine is ready to welding & annealing processes. The machine waits the user to pressing START button.

**Search Program:** To search and load particular program with easily. Only three characters are enough to find the desired program.

**CONTINUE WITH LAST PROGRAM:** To load the last program used.

Following screen appears and the user can see the all set values on this screen.

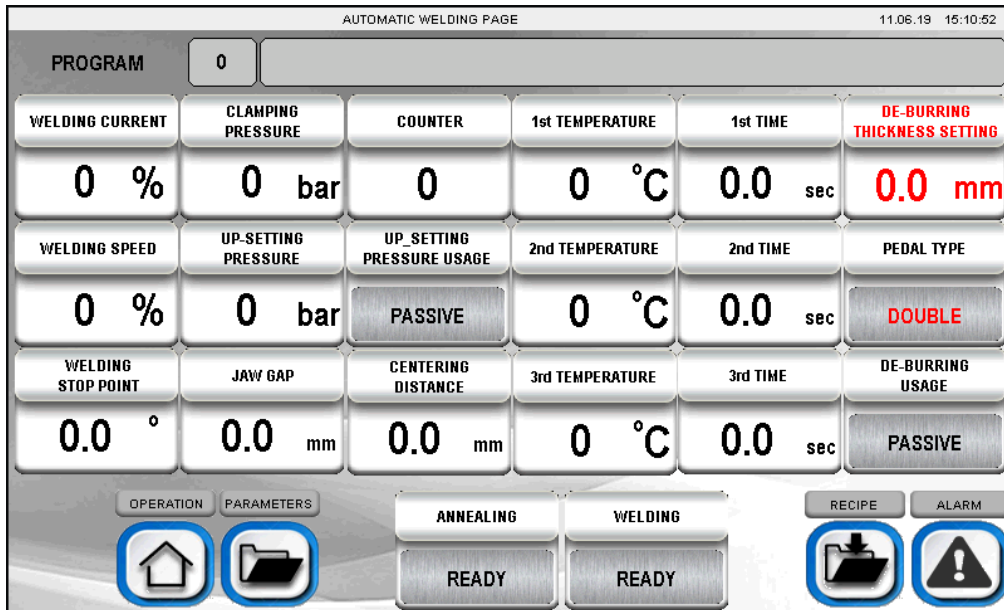

When the user press the 'START' button;

If operator wants to change a parameter and save it to the next operations, the recipe button should be use. This button helps to save the parameters for that program. When all parameters are desirable the operator could follow steps to do not lose the parameters.

Click RECEIPT button and then click SAVE button to save parameters with the exist name.

Following screen shown in automatic Welding & Annealing Mode while in process. The line bottom on the screen describes the processes which have been done.

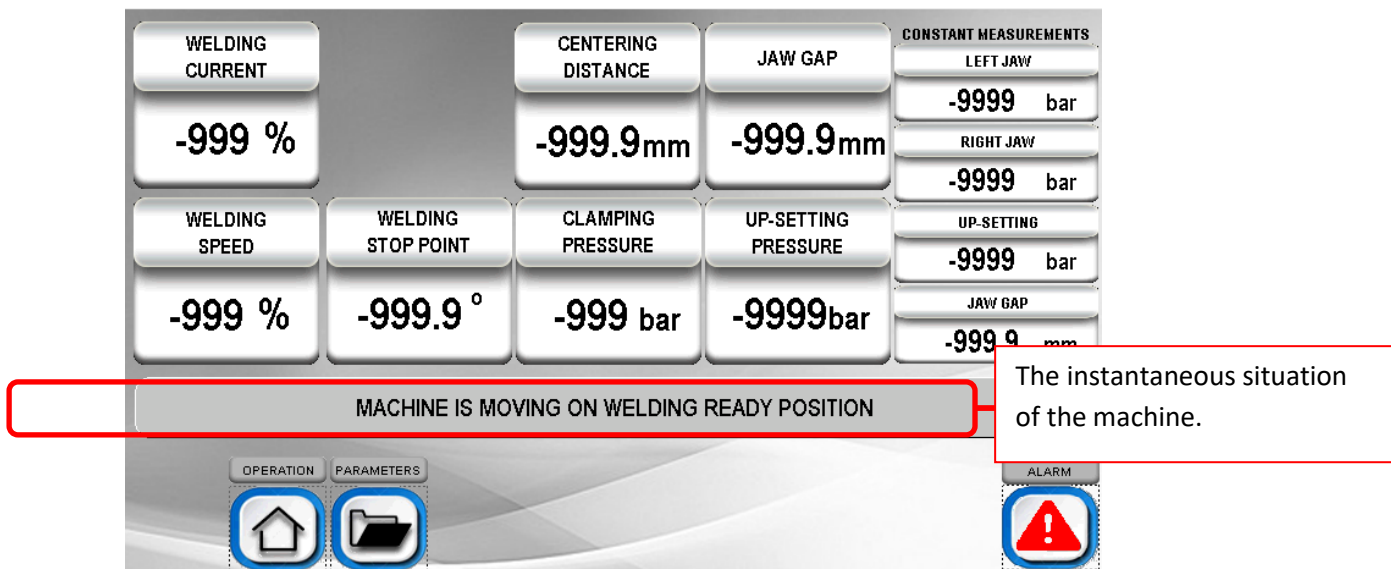



**AUTOMATIC ANNEALING SCREEN:**

Mainly, screen divided to two sections. First section is left side which indicates and draws a graph the actual values of the annealing process. The right side indicates the 'Adjusted Temperature', 'Measured Temperature', 'Annealing Time' and 'Transformator Value'. The values of right section may change every stage of the annealing process because of the annealing process finalize in three different stage.

If explain the workflow diagram shortly;

First of all, machine provides the temperature that 1<sup>st</sup> annealing temperature, and then the machine applies the heat for given time interval by the operator. Other stages are also similar, the previous stages repeat. The critical point is the controlled heating and cooling stages which is the first and last section of the graph.

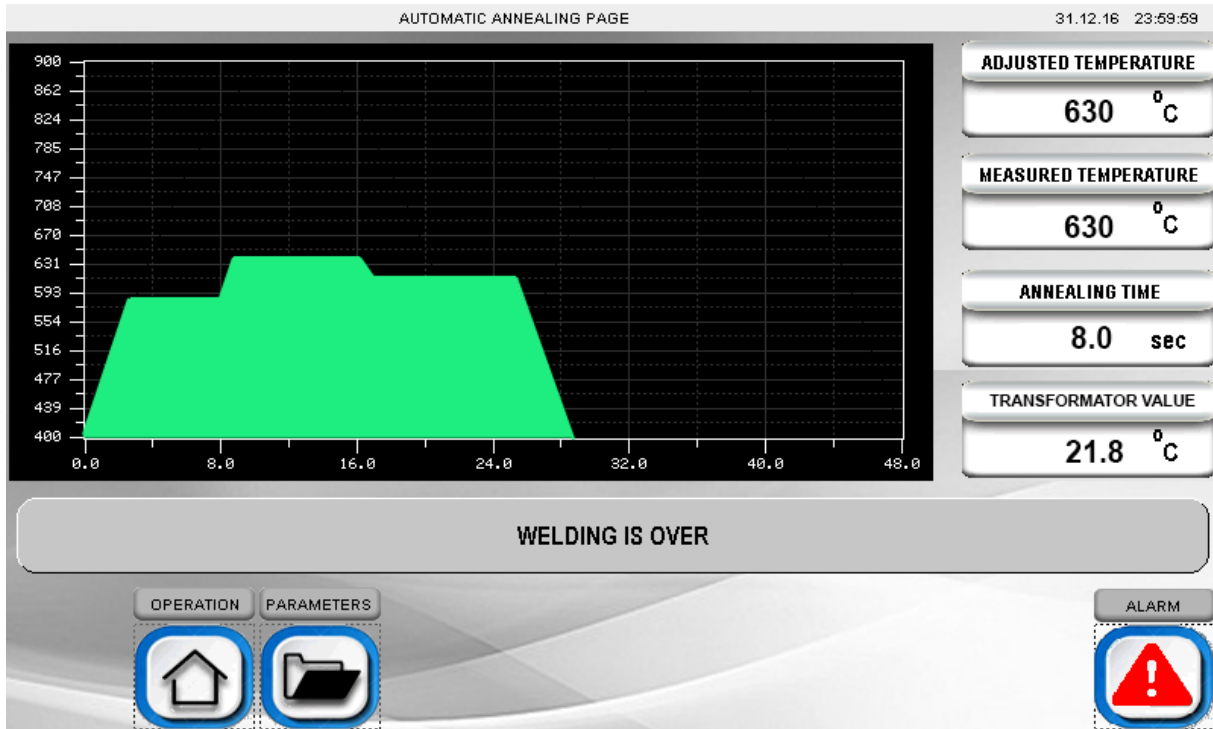



Additionally, the annealing times starts at the degree which given by the operator. Before the annealing process the material is heated and after annealing process the material is cooled under control by the PLC. The descriptions of time intervals are shown below at the graph.

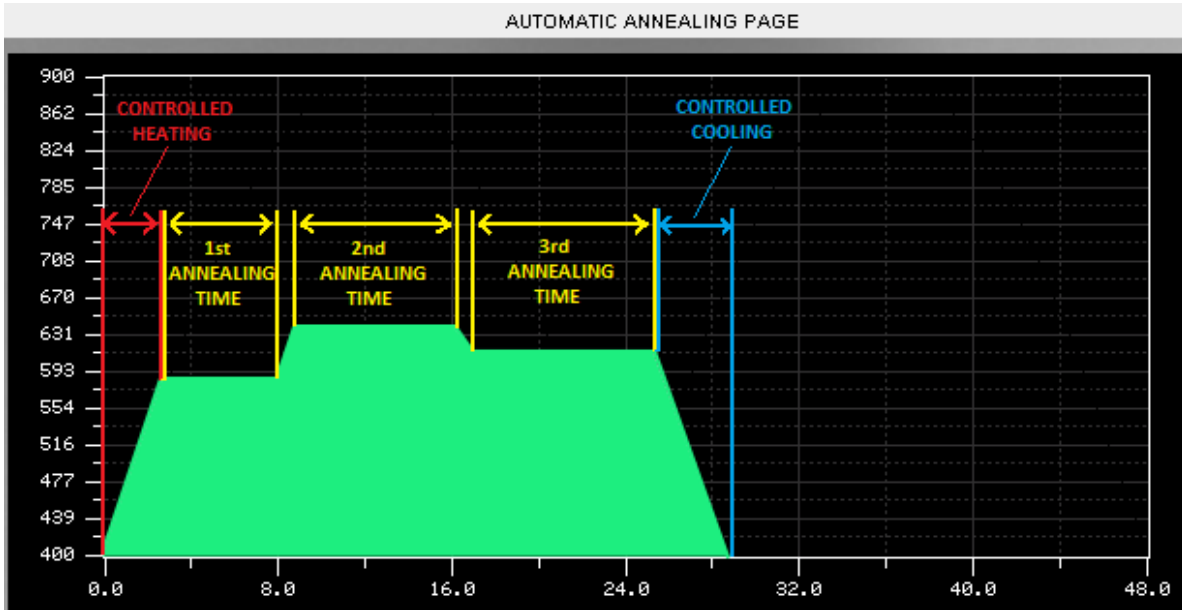

#### SAVING OF PARAMETERS:



**USB >> PANEL SAVE:** This option helps to you Welding & Annealing settings transfer from USB Memory Stick to the Machine.(For this operation Barcode reader USB input could use.)

**PANEL >> USB SAVE:** This option helps to you Welding & Annealing settings transfer from the Machine to USB Memory Stick. (For this operation Barcode reader USB input could use.)

**ALARM SECTION:**

The any fault occurs in an operation records into Alarm section. Alarm section is accessible from at right bottom side of the every screen.



The all faults are seen in the following screen. Fault can be select by the help of the arrows and to delete a fault the user can click the trash can button.

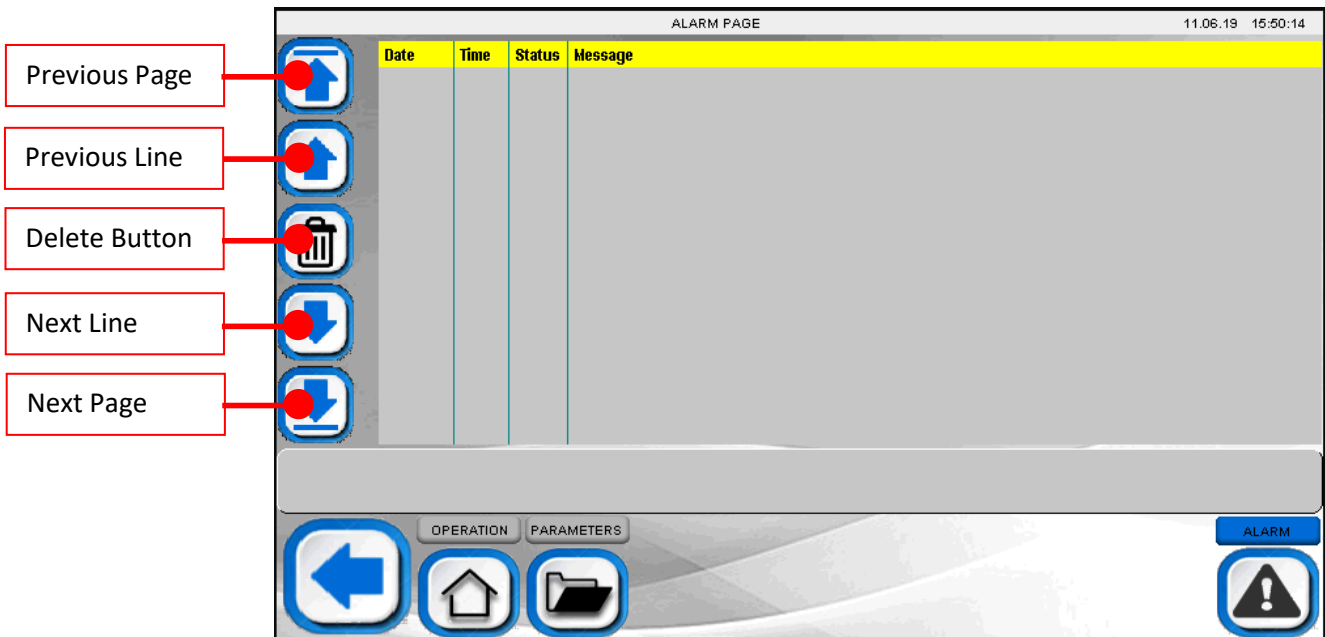

**THE MESSAGES:**

**EMERGENCY STOP IS ACTIVE:** Please check emergency stop buttons.

**HYDRAULIC MOTOR FAULTED:** Please check thermal fuse of the motor.

**PHASE LOSS FAULT:** Please check sequence of phases and check connection of all phases.

**MAIN AIR PRESSURE IS UNDER THE LIMITS:** Please provide air to the machine more than 7 bar.

**CAM SERVO DRIVE IS FAULTED:** First, check the hydraulic oil level of up-set pressure piston. Secondly, check coupling of the cam servo motor drive for any visible damage. If there is no change in the alarm, contact with the Temelsan technic personnel.

**UP-SETTING SERVO DRIVE IS FAULTED:** The hydraulic oil level of Up-Set pressure piston may be high. Check the oil level of Up-Set pressure piston. If the oil level is OK, contact with the Temelsan technic personnel.

**SYSTEM COULD NOT GET THE REFERENCE:** General safety warning.

**REFERENCE PROCEDURE IS RUNNING:** It is only information for user.

**LEFT JAW CLAMPING PRESSURE IS OUT OF THE LIMIT TOLERANCE:** Left jaw pressure out of the tolerance limit.

**RIGHT JAW CLAMPING PRESSURE IS OUT OF THE LIMIT TOLERANCE:** Right jaw pressure out of the tolerance limit.

**UP-SETTING PRESSURE IS OUT OF THE LIMIT TOLERANCE:** Up-Set pressure out of the tolerance limit.

**JAW GAP SENSOR CALIBRATION IS WRONG:** Go to the reference screen and click to " START REFERENCE" to calibrate the machine.

**CHECK THE PROGRAM VALUES:** Please check your receipt values. Your welding setting are anomalous.

**I/O TEST SECTION:**

31.12.16 23:59:59
PLC INPUT OUTPUT MONITORING

PLC-I	PLC-O	NX-DA3603	NX-AD3603	NX-AD3203
00	00	-99999	-99999	-99999
01	01	-99999	-99999	-99999
02	02	-99999	-99999	-99999
03	03	-99999	-99999	-99999
04	04	-99999	-99999	-99999
05	05	-99999	-99999	-99999
06	06	-99999	-99999	-99999
07	07	-99999	-99999	-99999
08	08	-99999	-99999	-99999
09	09	-99999	-99999	-99999
10	10	-99999	-99999	-99999
11	11	-99999	-99999	-99999
12	12	-99999	-99999	-99999
13	13	-99999	-99999	-99999
22	22	-99999	-99999	-99999
23	23	-99999	-99999	-99999

OPERATION

PARAMETERS

SERVICE

ALARM









The descriptions of I/O Test module is below.

PLC-I	DESCRIPTION	PLC-O	DESCRIPTION
00	THERMAL SWITCH FAULT	00	HYDRAULIC PUMP
01	START BUTTON	01	LEFT JAW AIR BLOW VALVE
02	STOP BUTTON	02	RIGHT JAW AIR BLOW VALVE
03	SPARK PROTECTION COVER SWITCH	03	PUSHER PISTON VALVE
04	DEBURRING CONTROL SENSOR	04	PYROMETER COVER VALVE
05	LEFT CLAMPING PEDAL	05	UP-SET PRESSURE THE LOWER VALVE
06	RIGHT CLAMPING PEDAL	06	UP-SET PRESSURE VALVE
07	PYROMETER COVER SWITCH	07	RIGHT CLAMPING VALVE
22	PHASE ROUTE ERROR	08	LEFT CLAMPING VALVE
23	EMERGENCY STOP BUTTON	09	DEBURRING BACK VALVE
		10	DEBURRING FORWARD VALVE
		11	STOP BUTTON LAMP
		12	START BUTTON LAMP
		13	PYROMETER LAMP

<b>NX-DA3603</b>	<b>NX-AD3603</b>	<b>NX-AD3203</b>
WELDING CURRENT	JAW GAP INDICATOR	PYROMETER
CLAMPING VALVE	MAIN PRESSURE	UP-SET PRESSURE
UP-SET PRESSURE VALVE		RIGHT JAW CLAMPING PRESSURE
		LEFT JAW CLAMPING PRESSURE



### JAW LEVEL CALIBRATION (CLAMPING JAW ANNEALING PRESSURE POINT)

There is on both Clamping Jaw Blocks a Jaw Level adjustment Screws they makes the adjustment very easy.

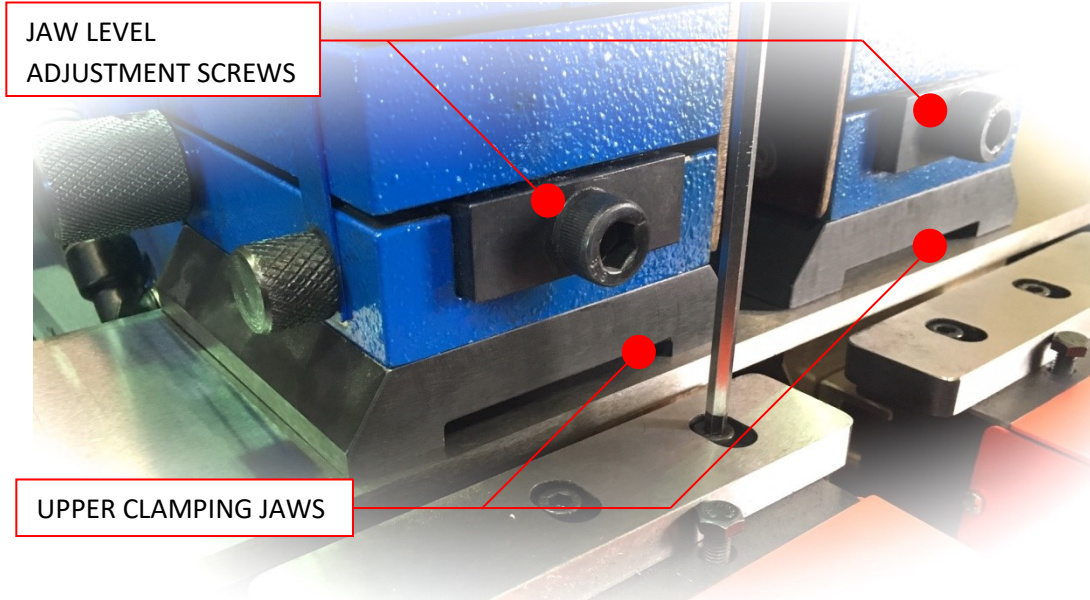

With changing of Annealing Press Point we are able to clamp properly all different width of Metal-Band

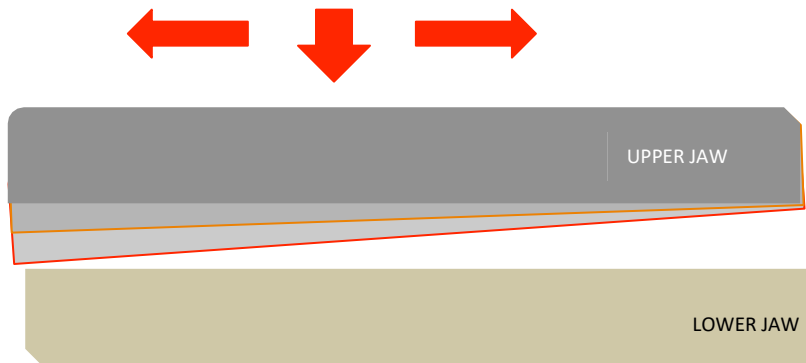

### Band Clamping Pressure Point

Where the pressure is higher, there is more electric connectivity, so the heat we want to create for proper annealing is there as highest. The goal is to create similar heat on all width of Metal-Band.

The jaw blocks are designed to be able to clamp different widths of Metal-Band or Band Saw Blade

#### Metal-Band Large Width Positioning

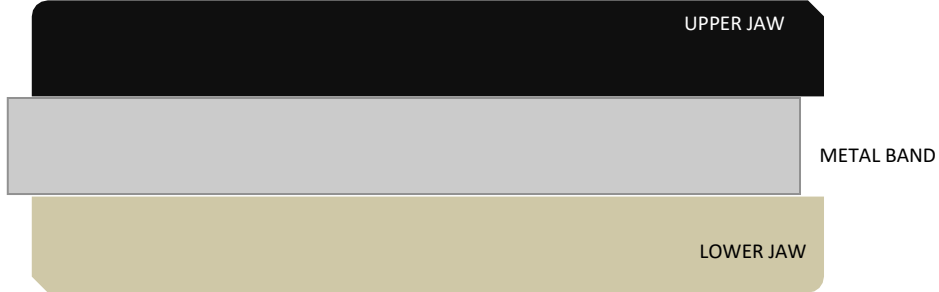

#### Metal-Band Small Width Positioning

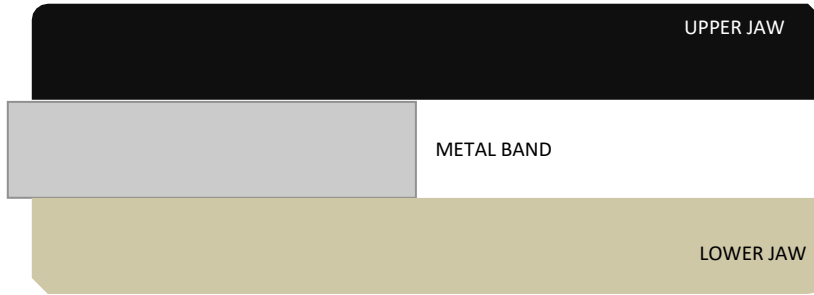

#### IMPORTANT TO KNOW!

The Clamping Pressure of the upper jaws has to be adjusted correctly in advance, in general is to know, as larger the band width as more clamping pressure can be used. There is recommended to memory the clamping pressures for each band size on a Parameter Chart.

What's happen when too high clamping pressure is adjusted.

In this case it's almost not possible to make a Jaw Level Calibration.

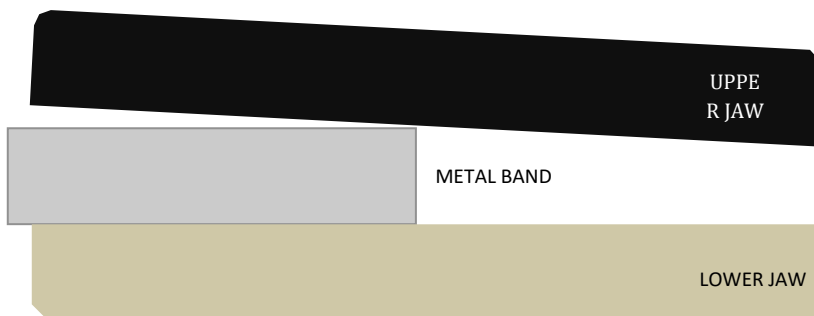

**Band Annealing Pressure Point (Jaw Level Calibration)**

Clamping Pressure should be correct for each selected band-width.

When Clamping Jaws are on annealing position and using the annealing procedure the heat will show where the Annealing Press Point are.

Where the pressure is, there is the electric connectivity higher, so the heat we want to create for proper annealing is there as highest. The goal is to create similar heat on all width of Metal-Band at the same time

like on picture # 1.

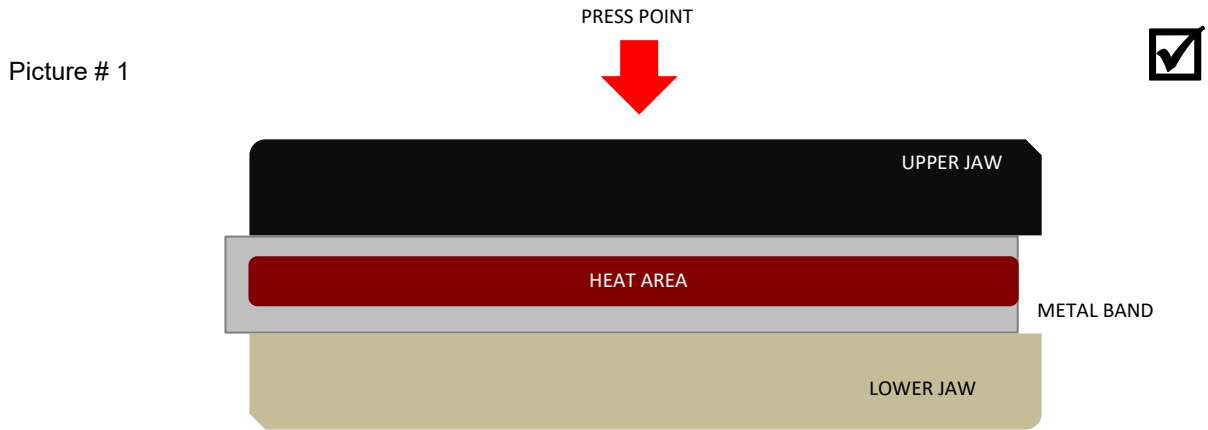

Picture # 2 **Improper Adjustment**

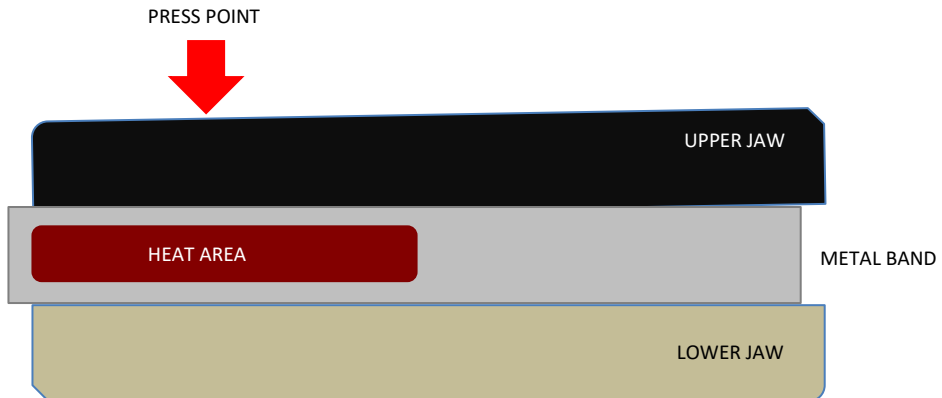
**Band Annealing Pressure Point (Jaw Level Calibration)**

TEMELSAN MAKİNA SAN. VE TİC. LTD. ŞTİ.

Akçaburgaz Mah. Muhsin Yazıcıoğlu Cad. No:55/1 Esenyurt / İstanbul / TÜRKİYE

TEL: +90 (212) 544-2518 FAX: +90 (212) 577-6557 [www.temelsan.com](http://www.temelsan.com) [temelsan@temelsan.com](mailto:temelsan@temelsan.com)

To keep similar Annealing clamping Press Point on both Clamping Jaws it's always recommended independently how tight the screws are turn able to work with an Allen key and using it as an dial like on a watch or dial indicator, in 5 minutes steps or 10 degree.

**IMPORTANT ALWAYS BOTH SCREWS ARE TO TURN AND ALWAYS SAME WAY THE SAME QUANTITY!**

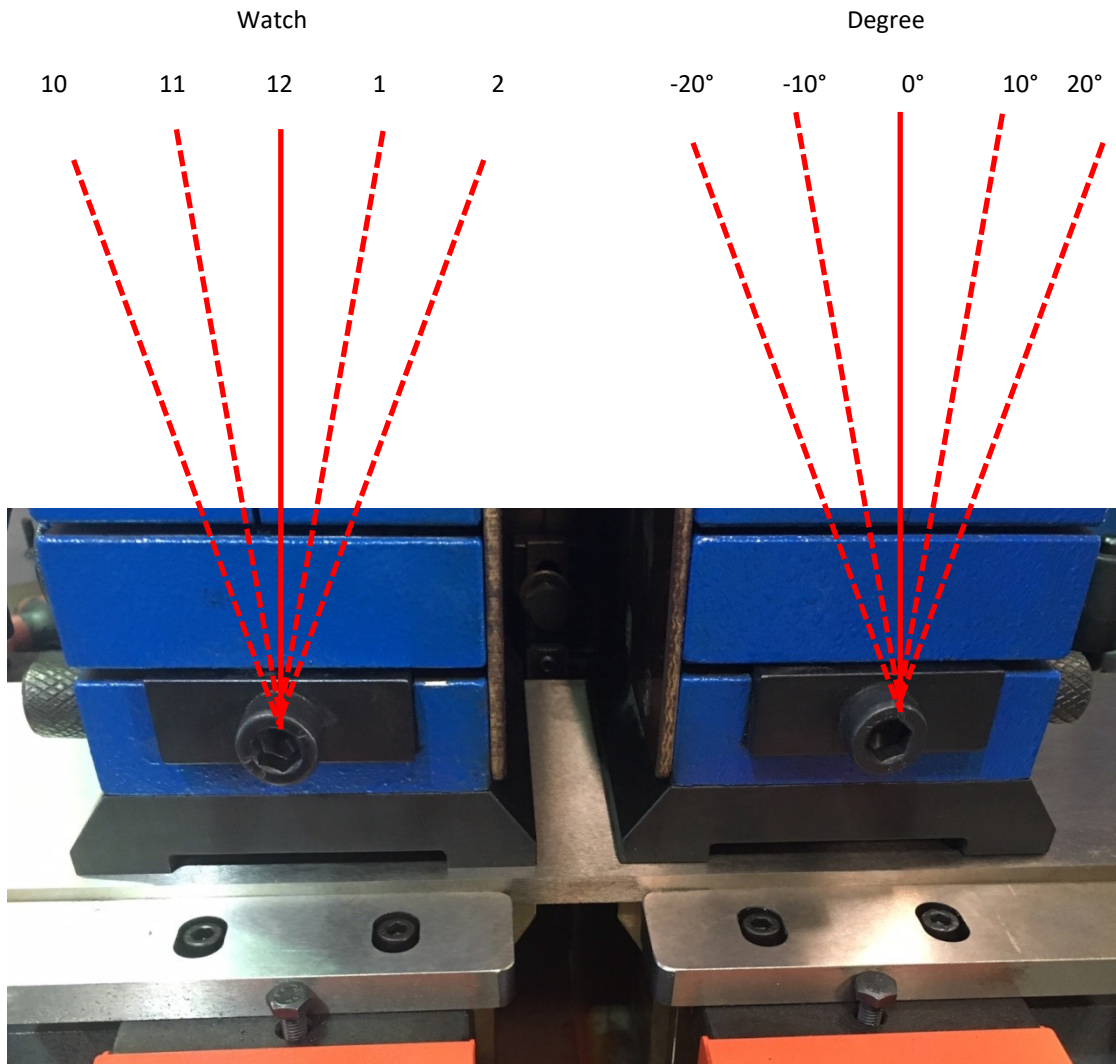

## JAW BLOCK LEVEL ADJUSTMENT

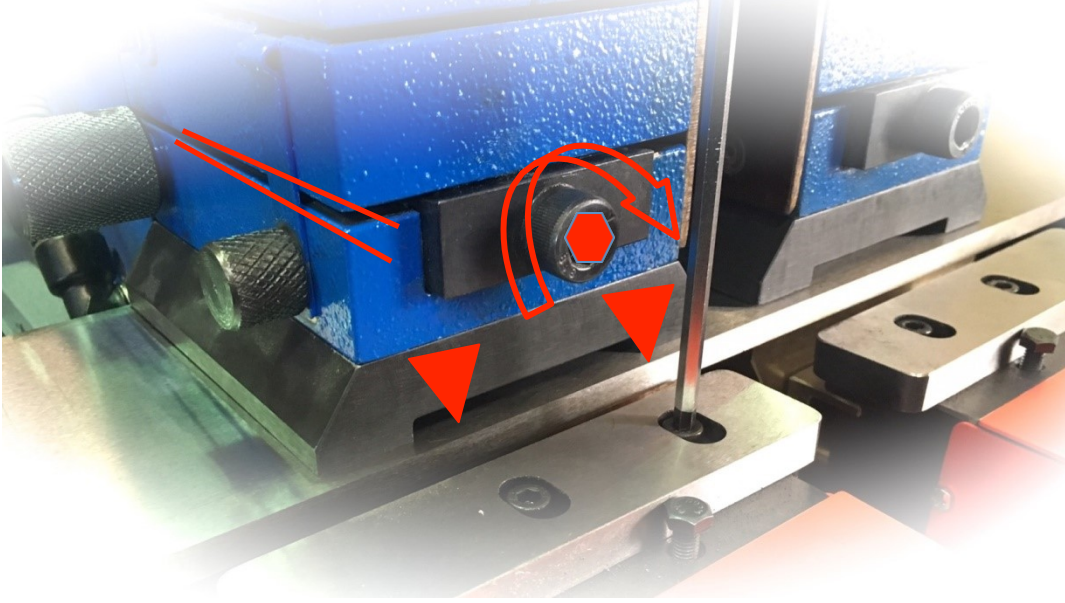

Turn the Jaw Level Adjustment Screw clock wise (to the right side) the Upper Jaw will create more clamping pressure on the front side. Turn the Jaw Level Adjustment Screw opposite direction (to the left side) the back clamping pressure between jaws will increase.



## CLAMPING JAW CALIBRATION BY CARBON PAPER

The calibration by Carbon paper brings more precision and is to use frequently after several position changings but for sure after Jaw replacement.

1. Position the Jaw Blocks to Annealing Ready Position
2. Adjust the Clamping Pressure to 300 Bar
3. Place the carbon paper package between jaws
4. Clamp both Jaws and wait few seconds
5. Take out the carbon paper package and study the picture
6. Adjust the jaws until you gain similar clamping picture over all width of both jaws
7. Place an 27mm Band, run an Annealing and watch where the heat starts, back edge or teeth edge side, depends adjust both Jaws to center the heat start to middle of Band.

### Carbon Paper Sandwich

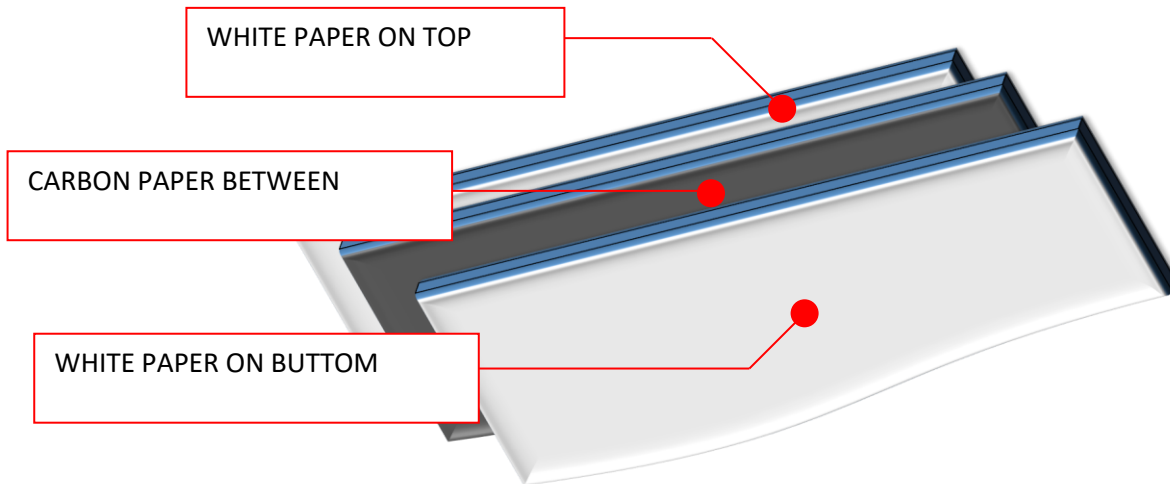

The Carbon Paper Print is showing similar print picture on both clamping jaws as an perfect similar adjustment.

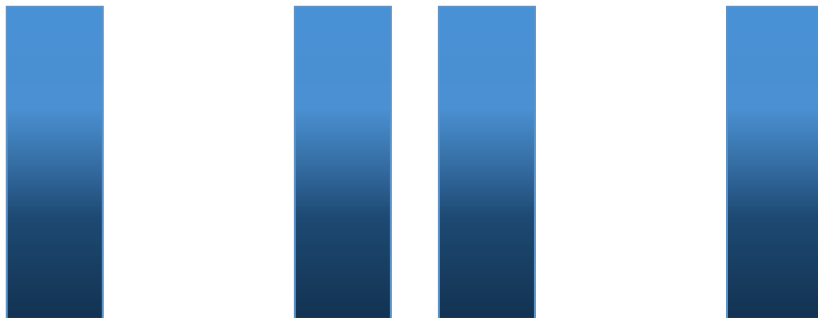

Left and right Jaw are not correct adjusted

Left Jaw too much back pressure or the right jaw too much front pressure, depends the band width



Left or right Jaw is not correct adjusted

Cross clamping; this type of adjustment can show when annealing an perfect center adjustment but the weld is not precise. Breakage it's possible.

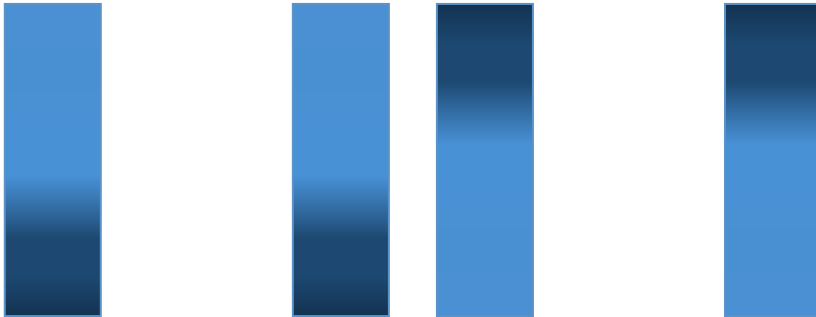

The Jaws have to be re-grinded with a high precision surface grind, have to be checked about deformation and correct fixed

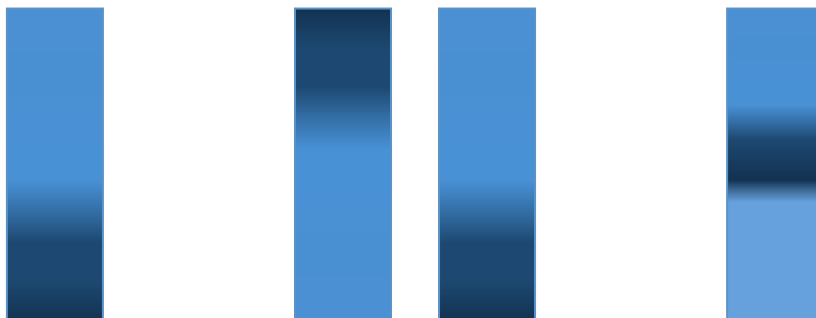

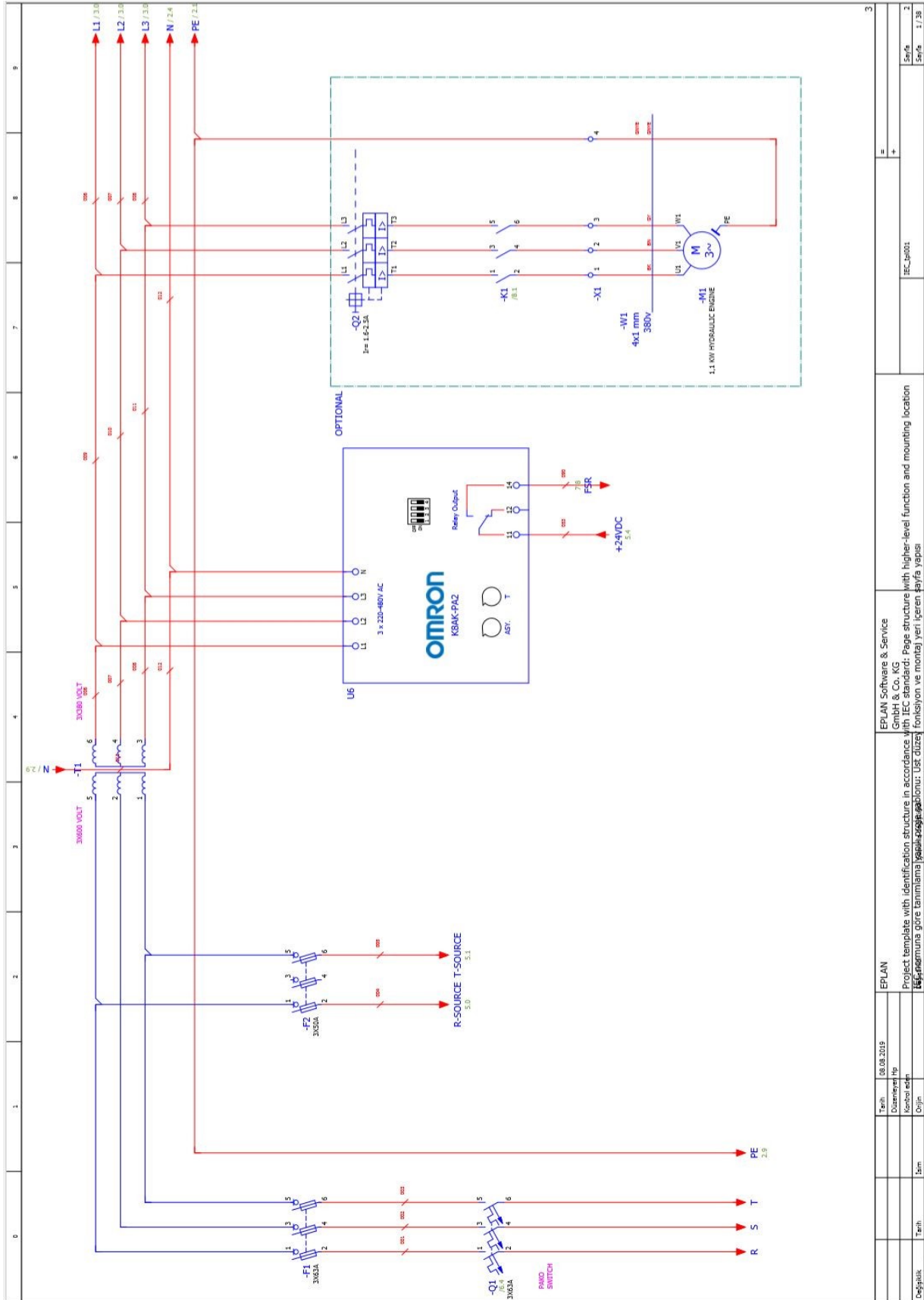
**SYSTEM DRAWINGS:**

TEMELSAN MAKİNA SAN. VE TİC. LTD. ŞTİ.

Akçaburgaz Mah. Muhsin Yazıcıoğlu Cad. No:55/1 Esenyurt / İstanbul / TÜRKİYE

 TEL: +90 (212) 544-2518 FAX: +90 (212) 577-6557 [www.temelsan.com](http://www.temelsan.com) [temelsan@temelsan.com](mailto:temelsan@temelsan.com)

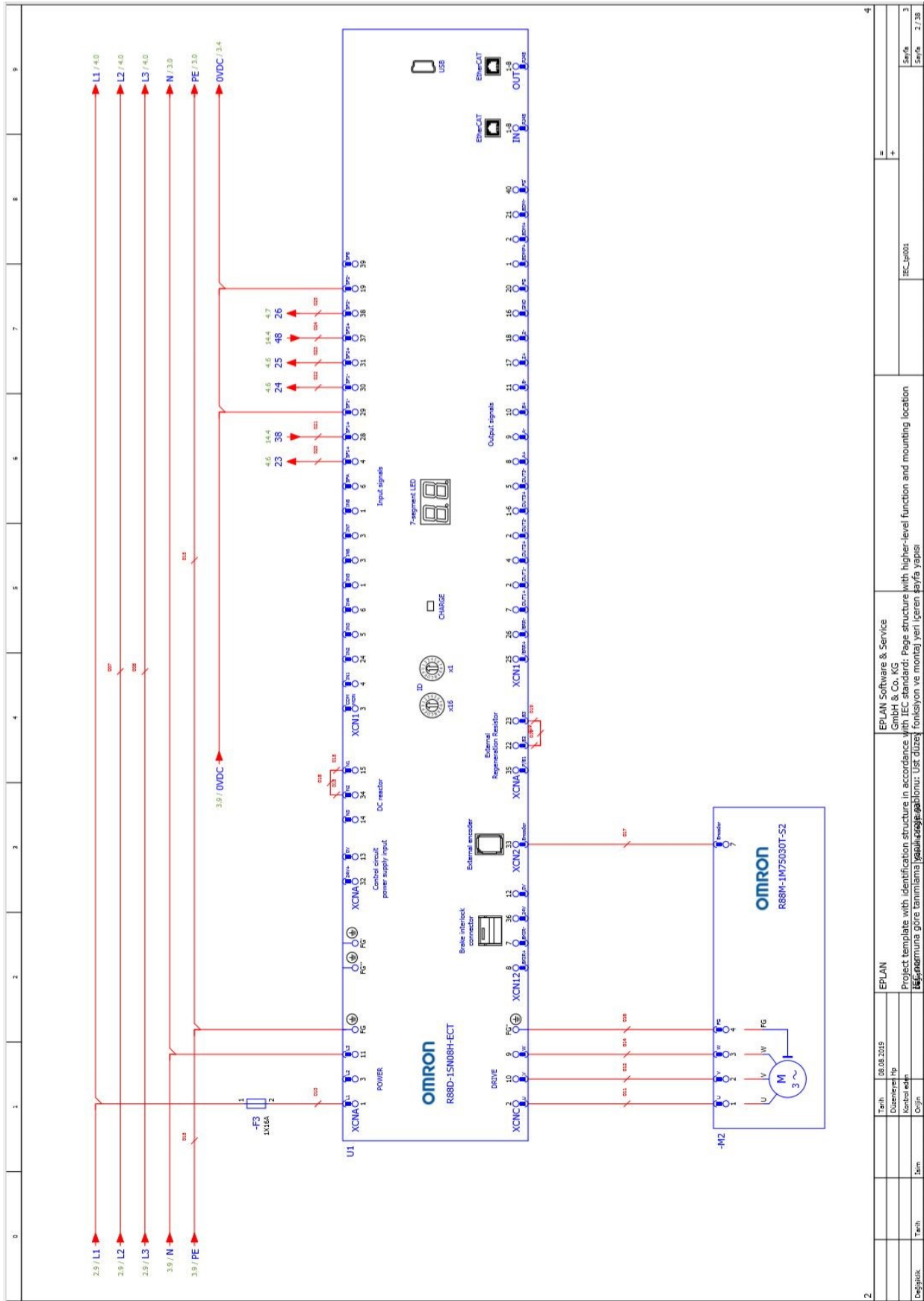

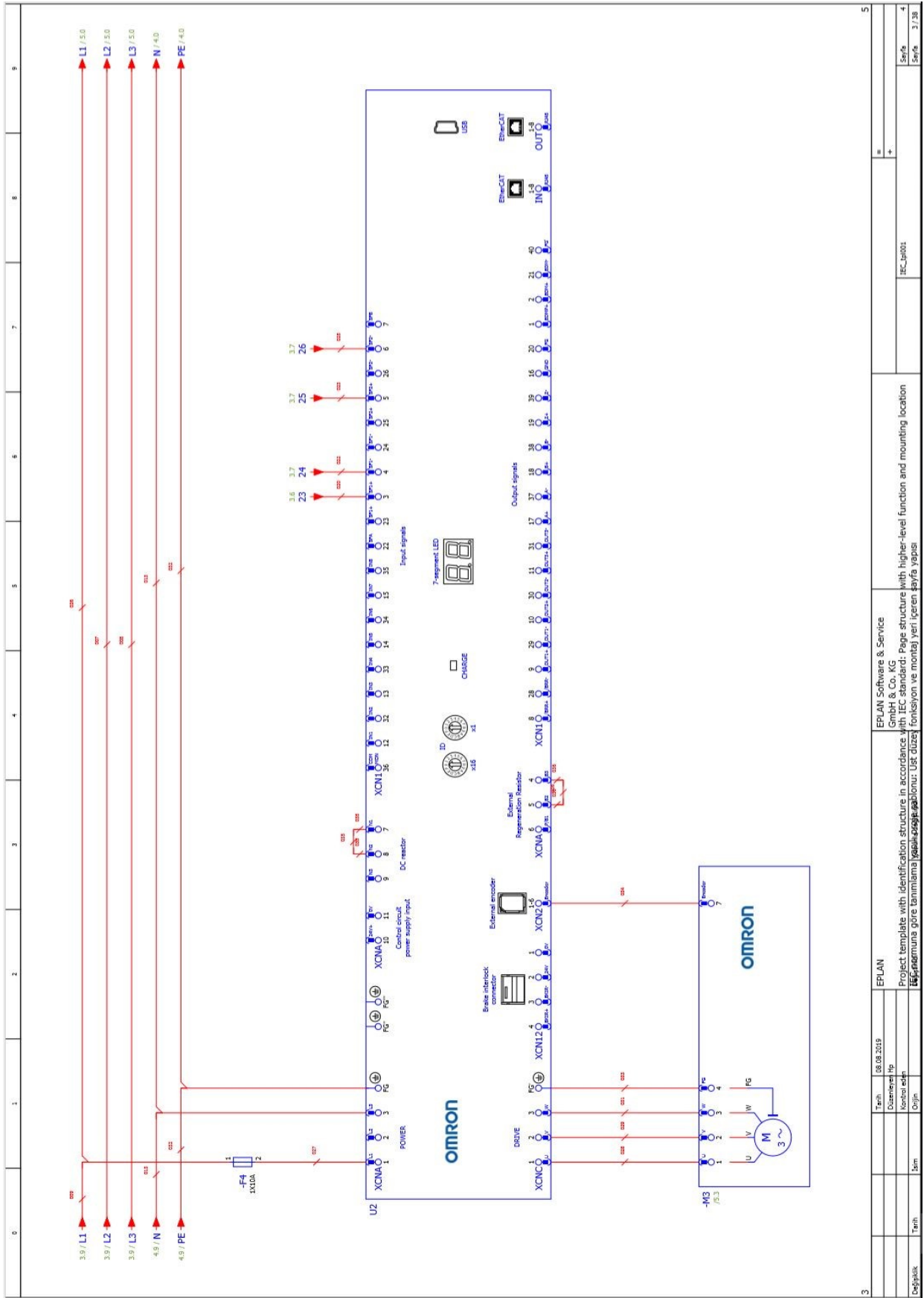





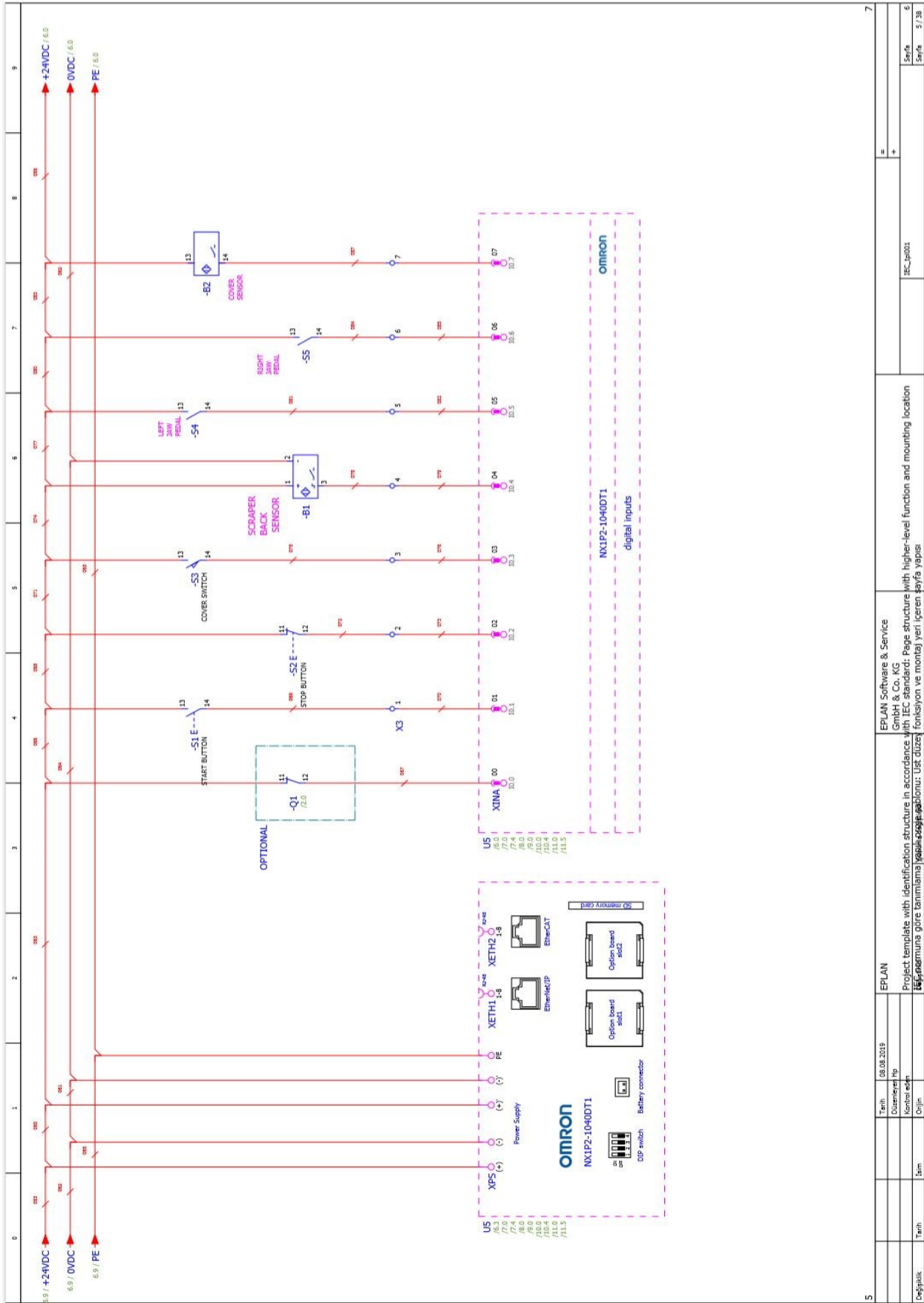

TEMELSAN MAKİNA SAN. VE TİC. LTD. ŞTİ.

Akçaburgaz Mah. Muhsin Yazıcıoğlu Cad. No:55/1 Esenyurt / İstanbul / TÜRKİYE

TEL: +90 (212) 544-2518 FAX: +90 (212) 577-6557 [www.temelsan.com](http://www.temelsan.com) [temelsan@temelsan.com](mailto:temelsan@temelsan.com)

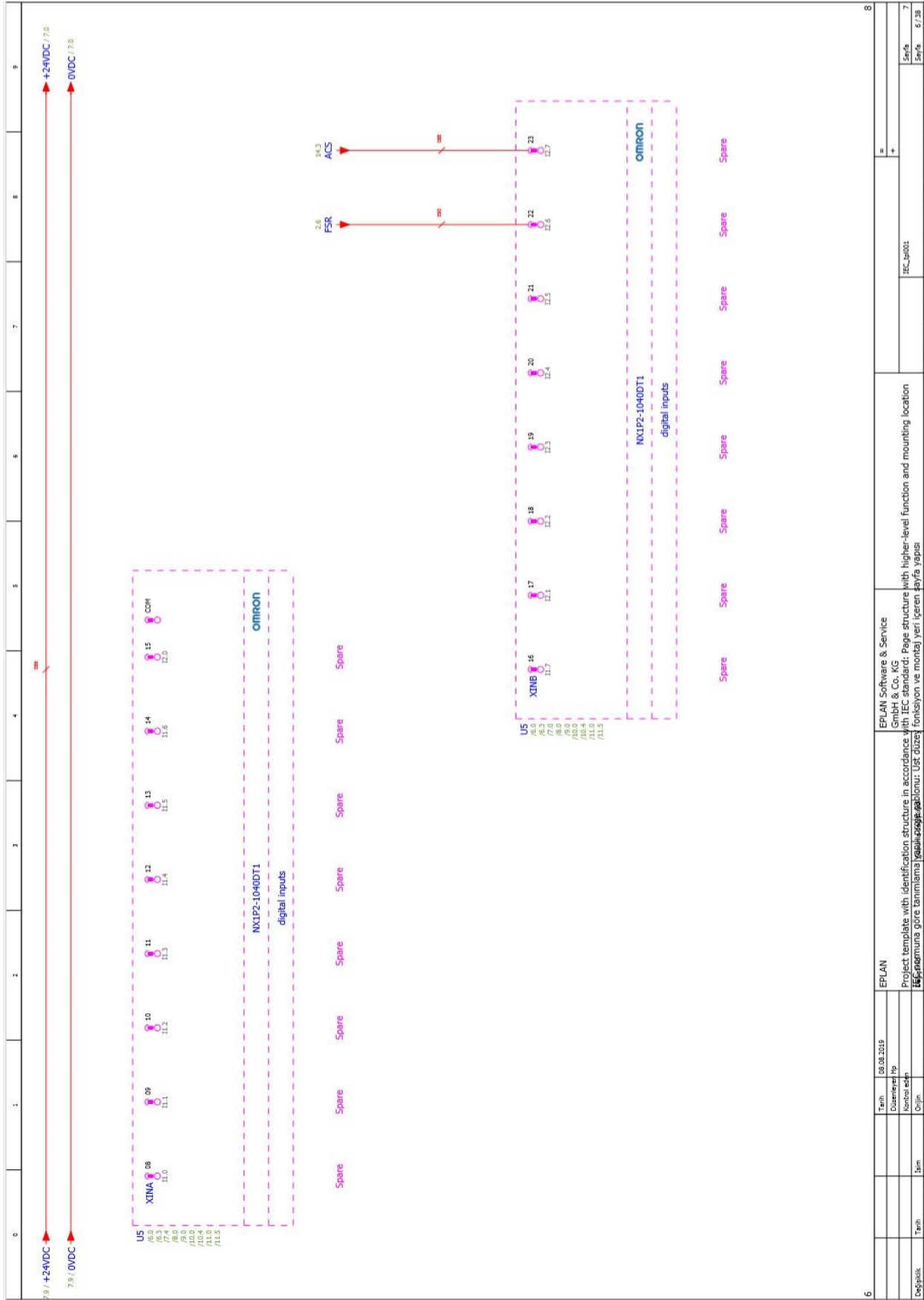



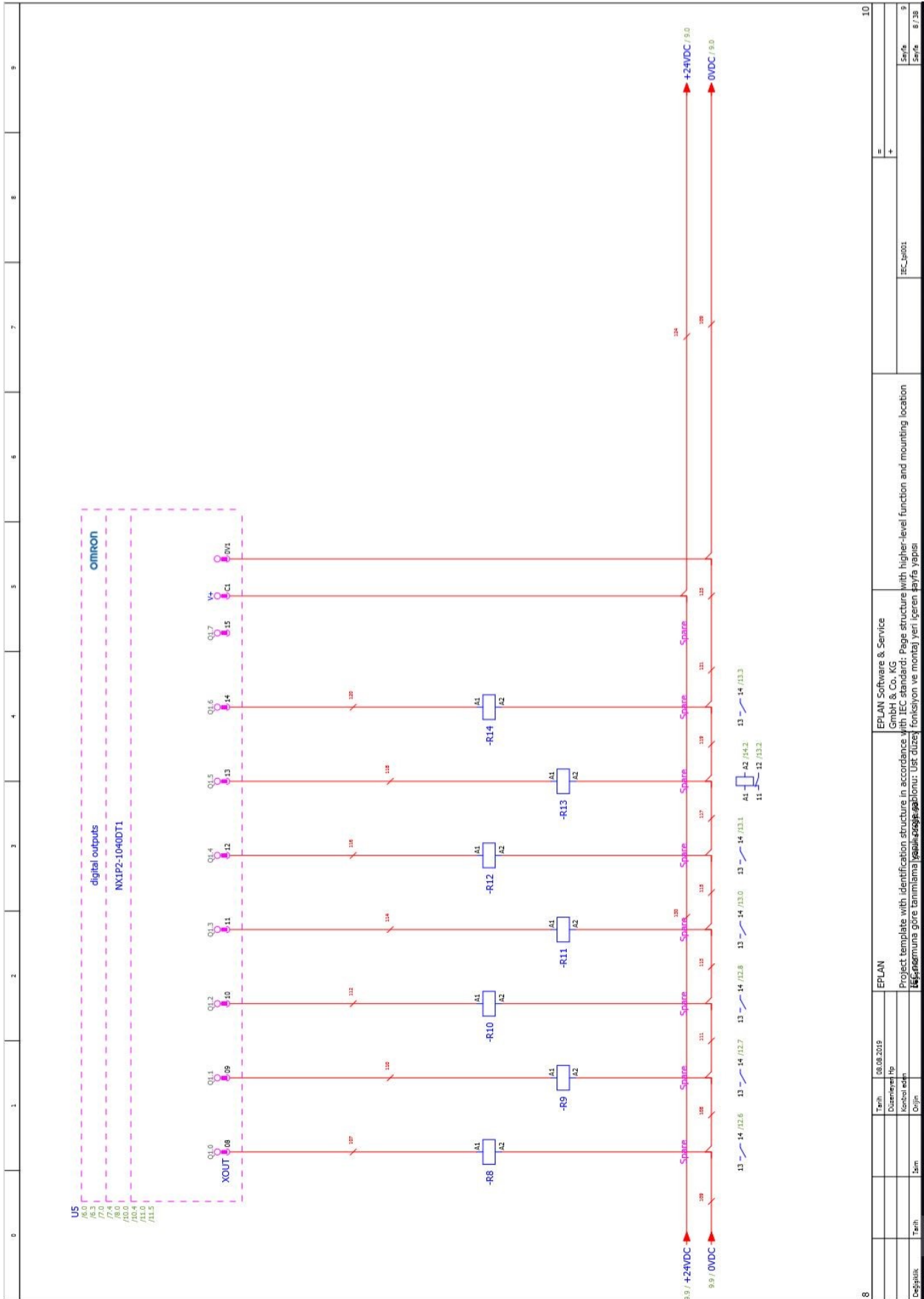



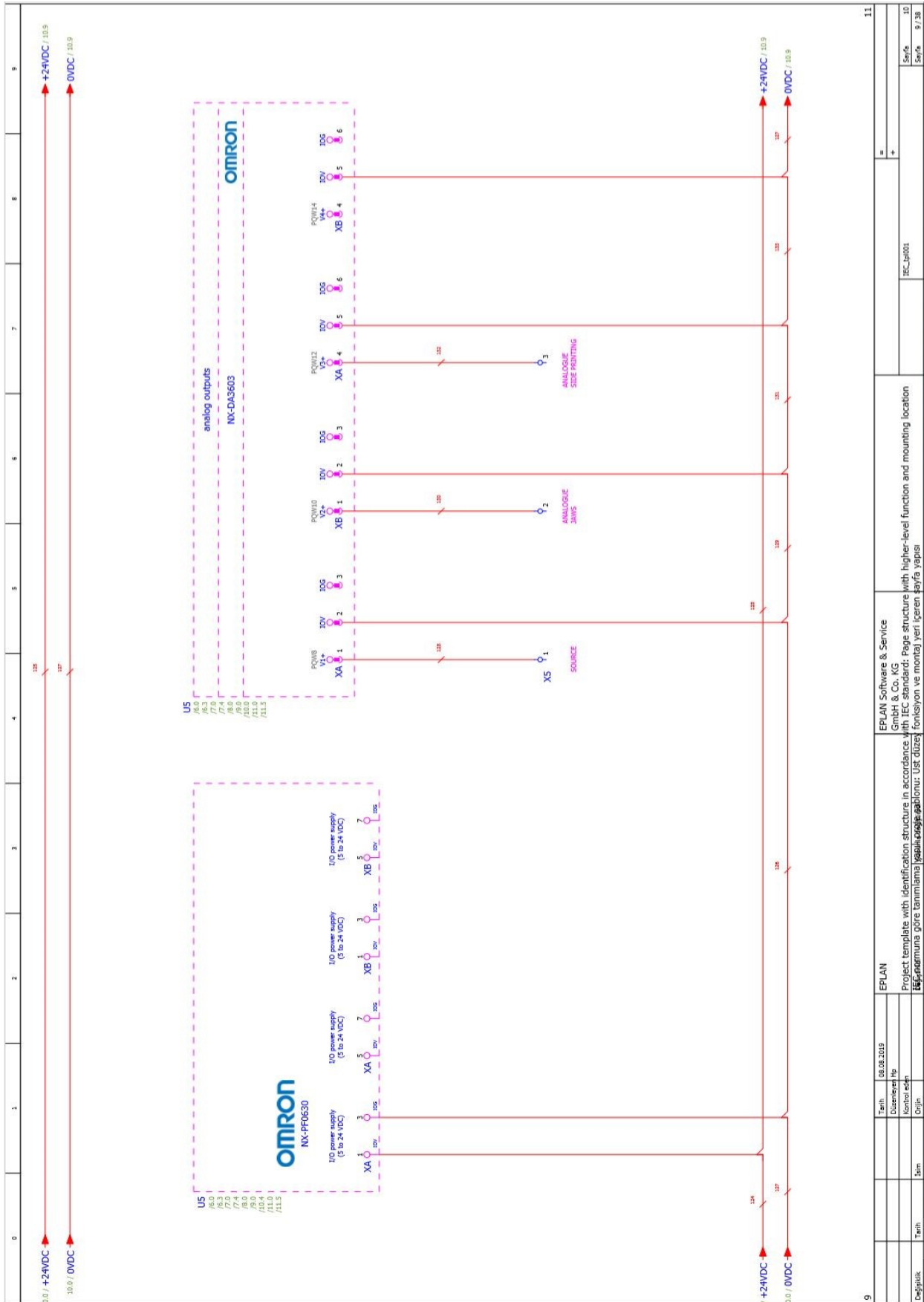



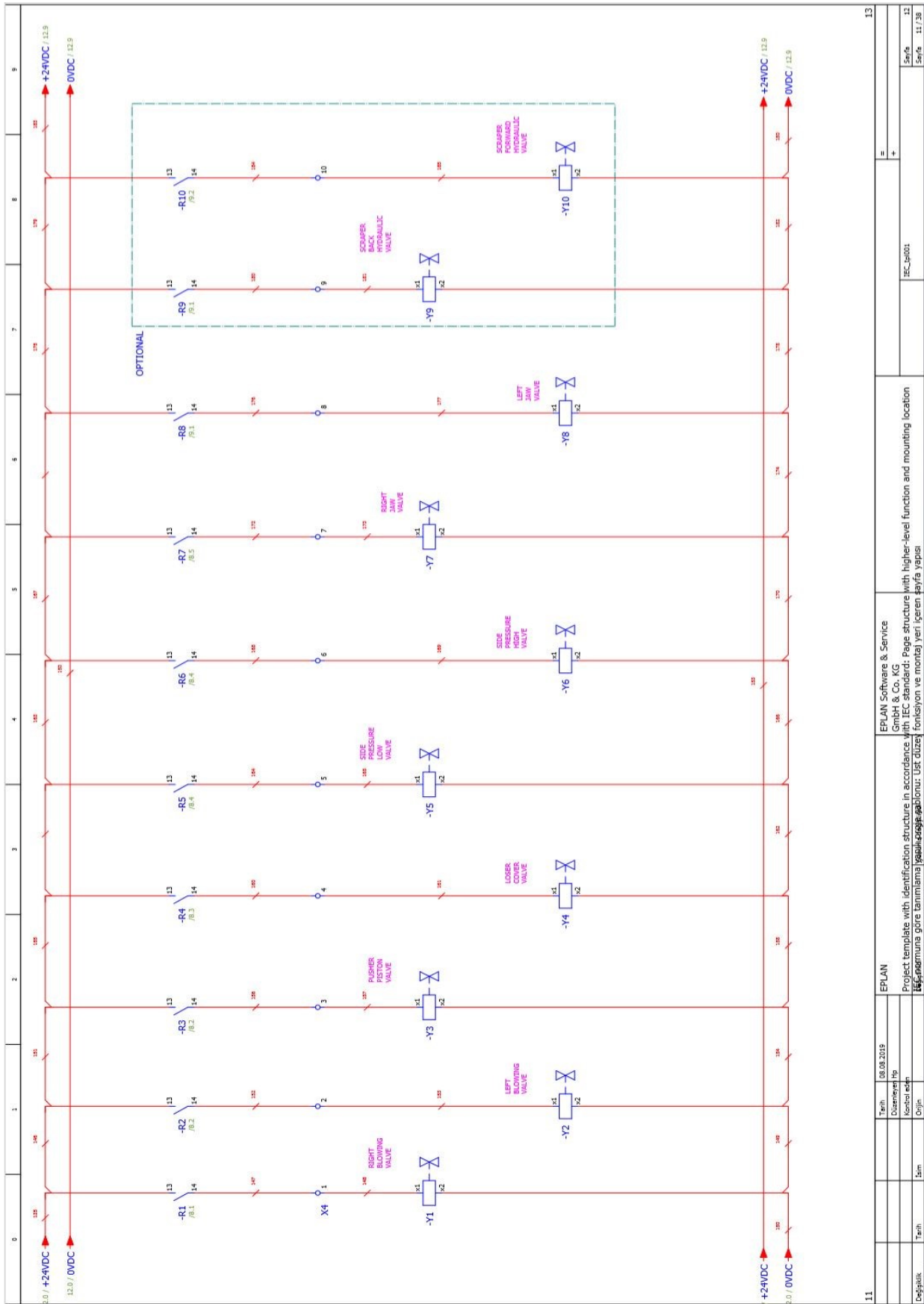

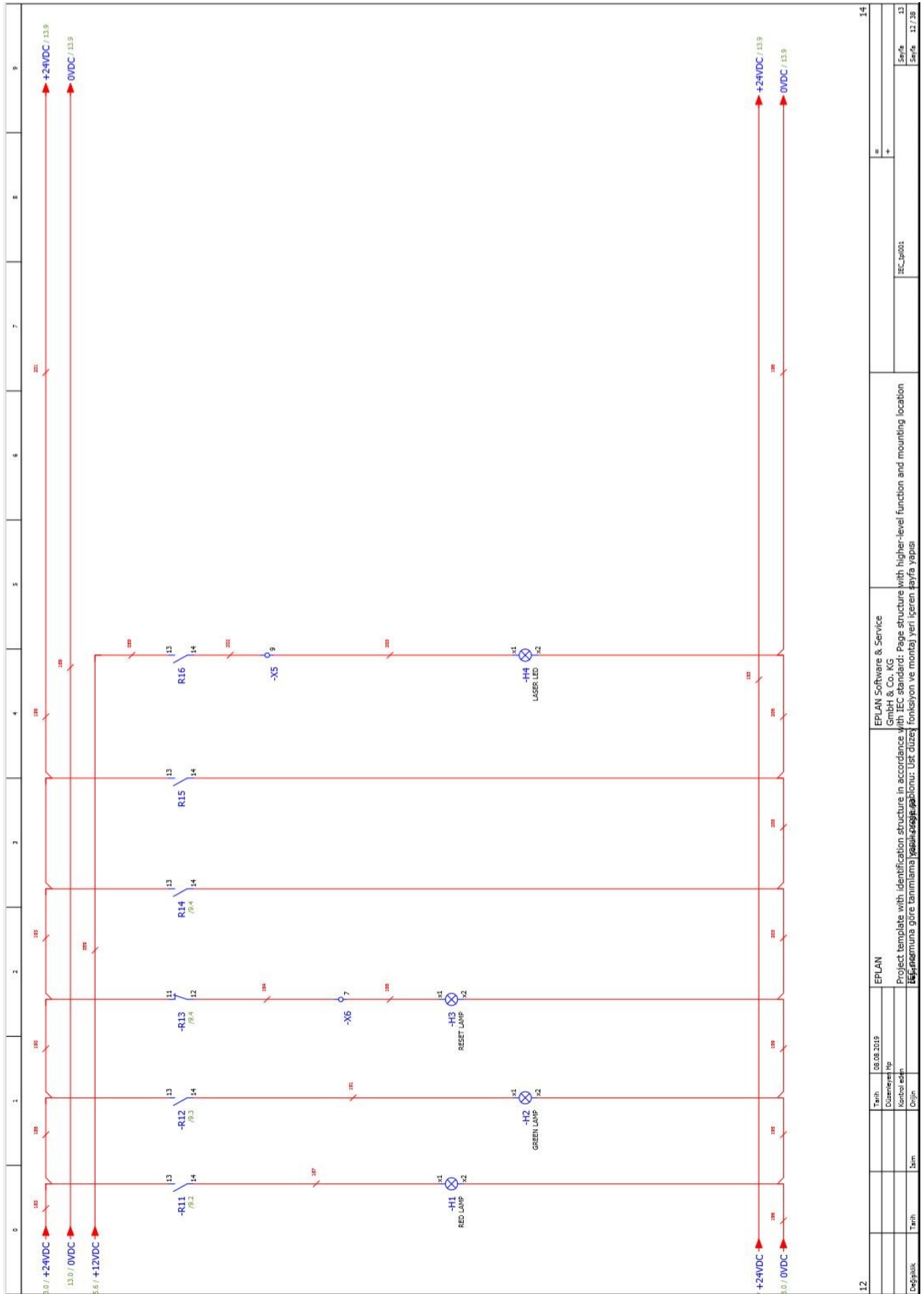





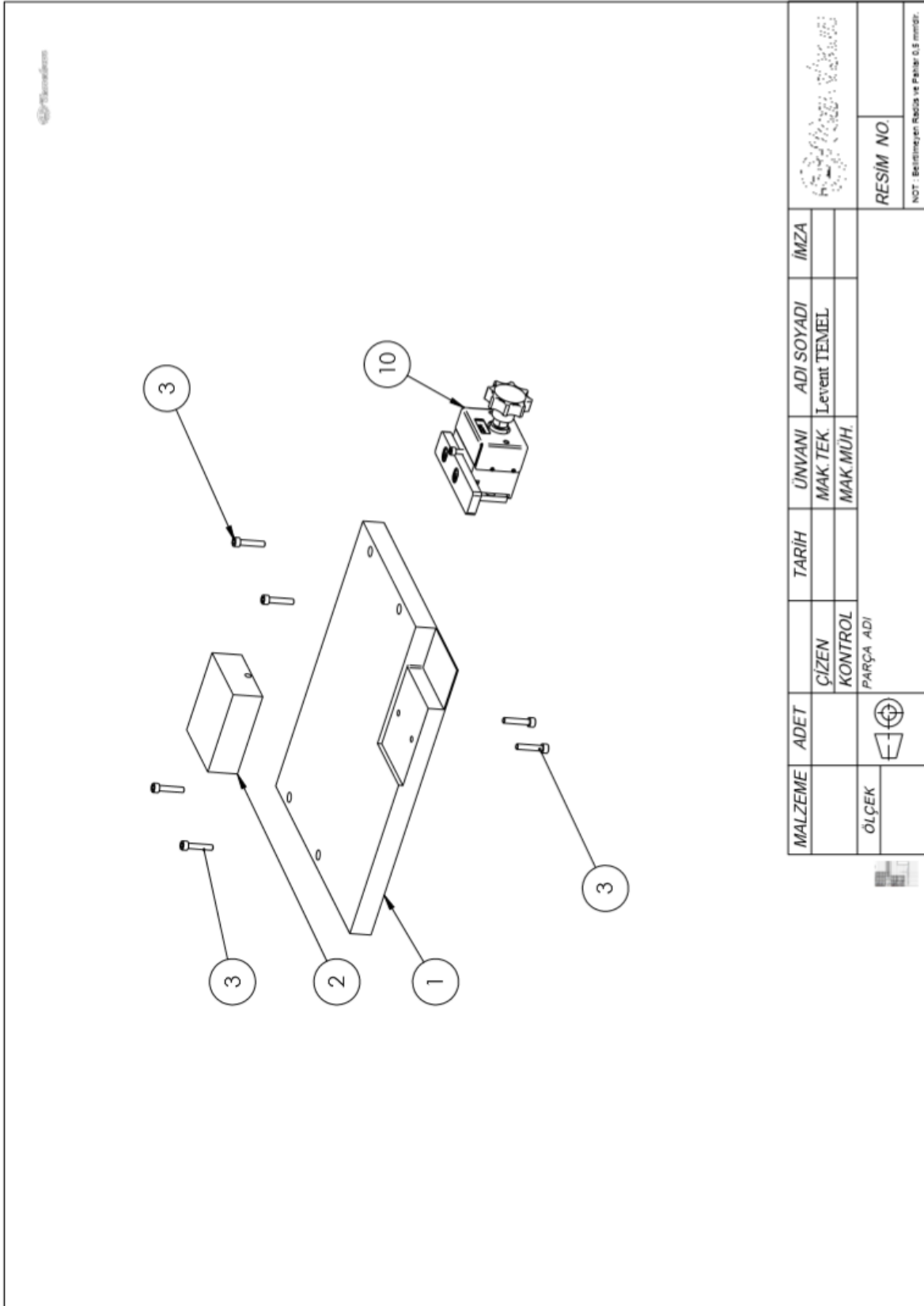

**SPARE PART DRAWINGS:**

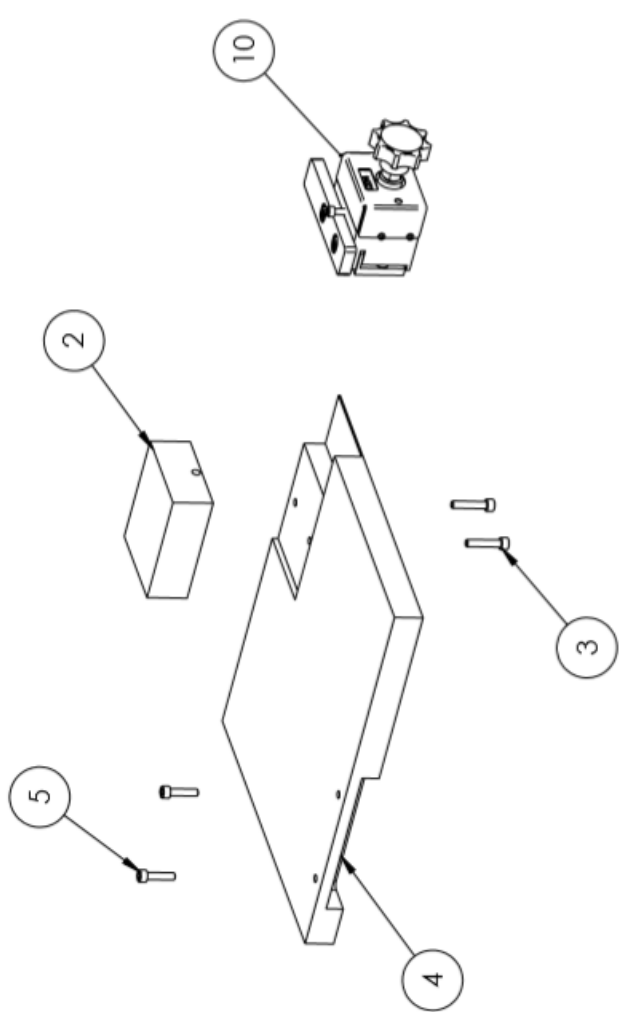

MALZEME	ADET	ÇİZEN	TARİH	ÜN VANI	ADI SOYADI	İMZA
	ÖLÇEK	KONTROL		MAK. TEK.	Levent TEMEL	
	PARÇA ADI			MAK. MÜH.		
						RESİM NO.

NOT: Belirtilmeyen RUCBA ve Pahalı 0,5 mm'dir.

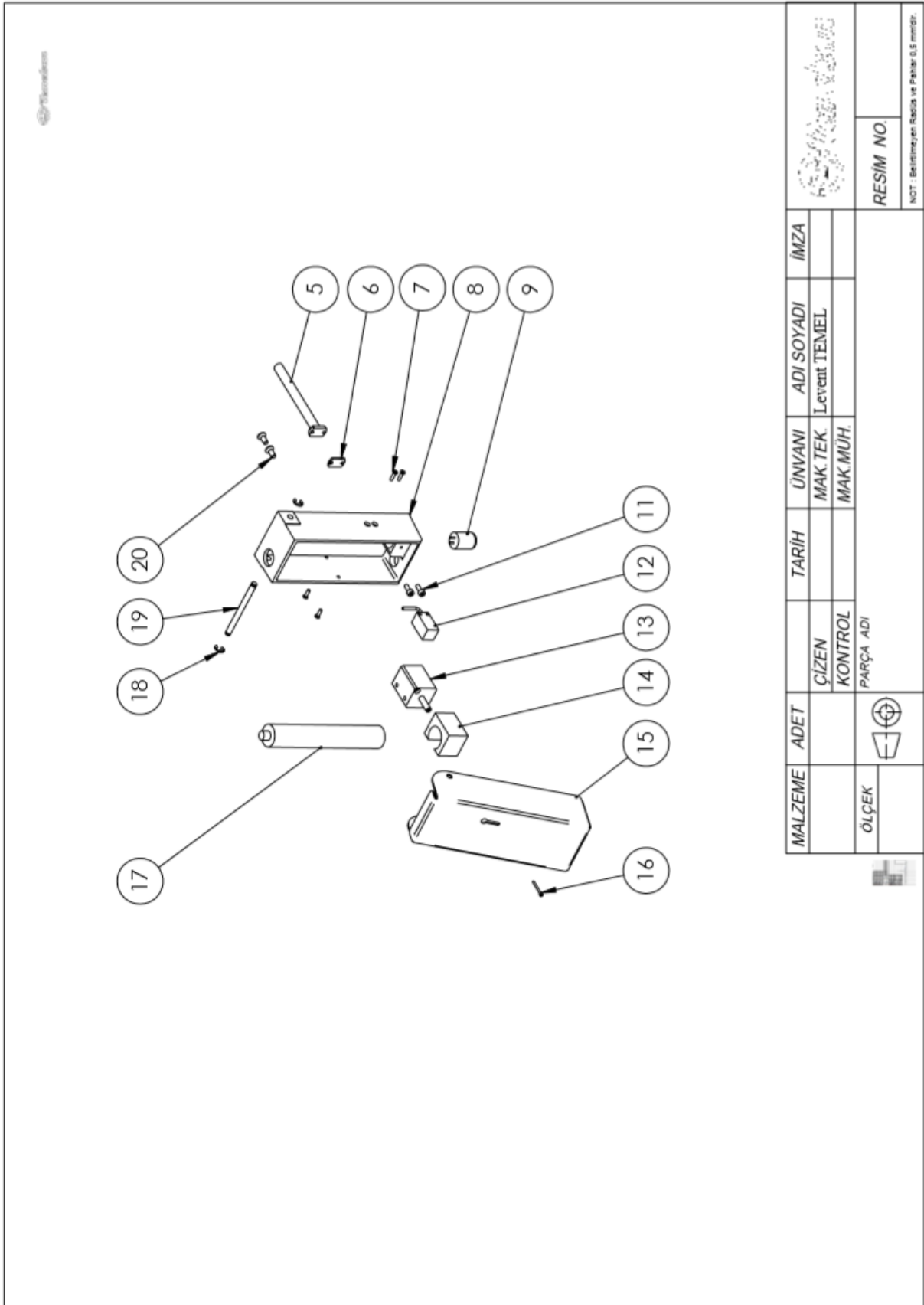

MALZEME	ADET	ÇİZEN	TARİH	ÜN VANI	ADI SOYADI	İMZA
	ÖLÇEK	KONTROL		MAK TEK	Levent TEMEL	
		PARÇA ADI		MAK MÜH		
						RESİM NO

NOT : Belirtilmeyen Raporlar ve Parçalar 0.8 mm'dir.





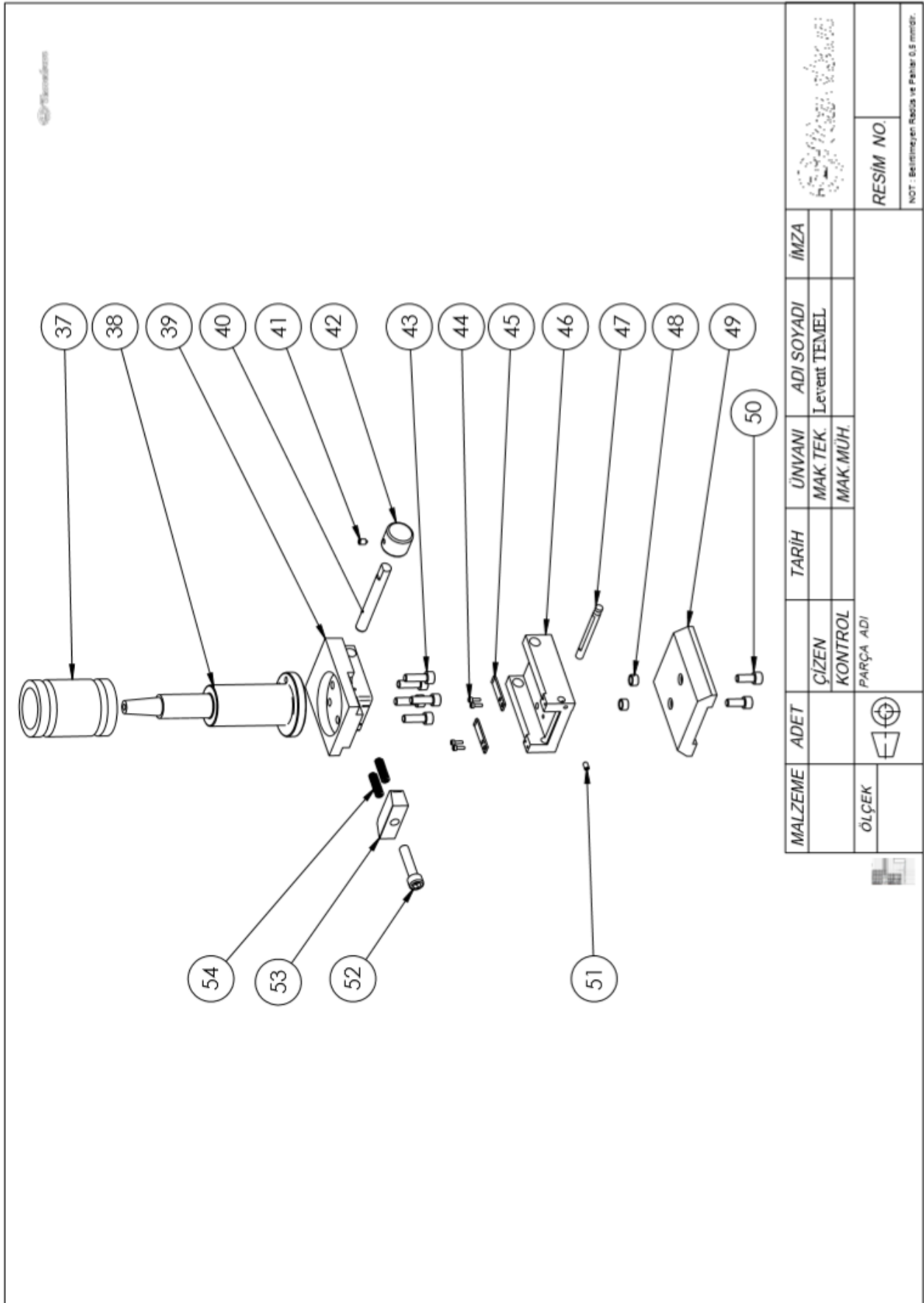



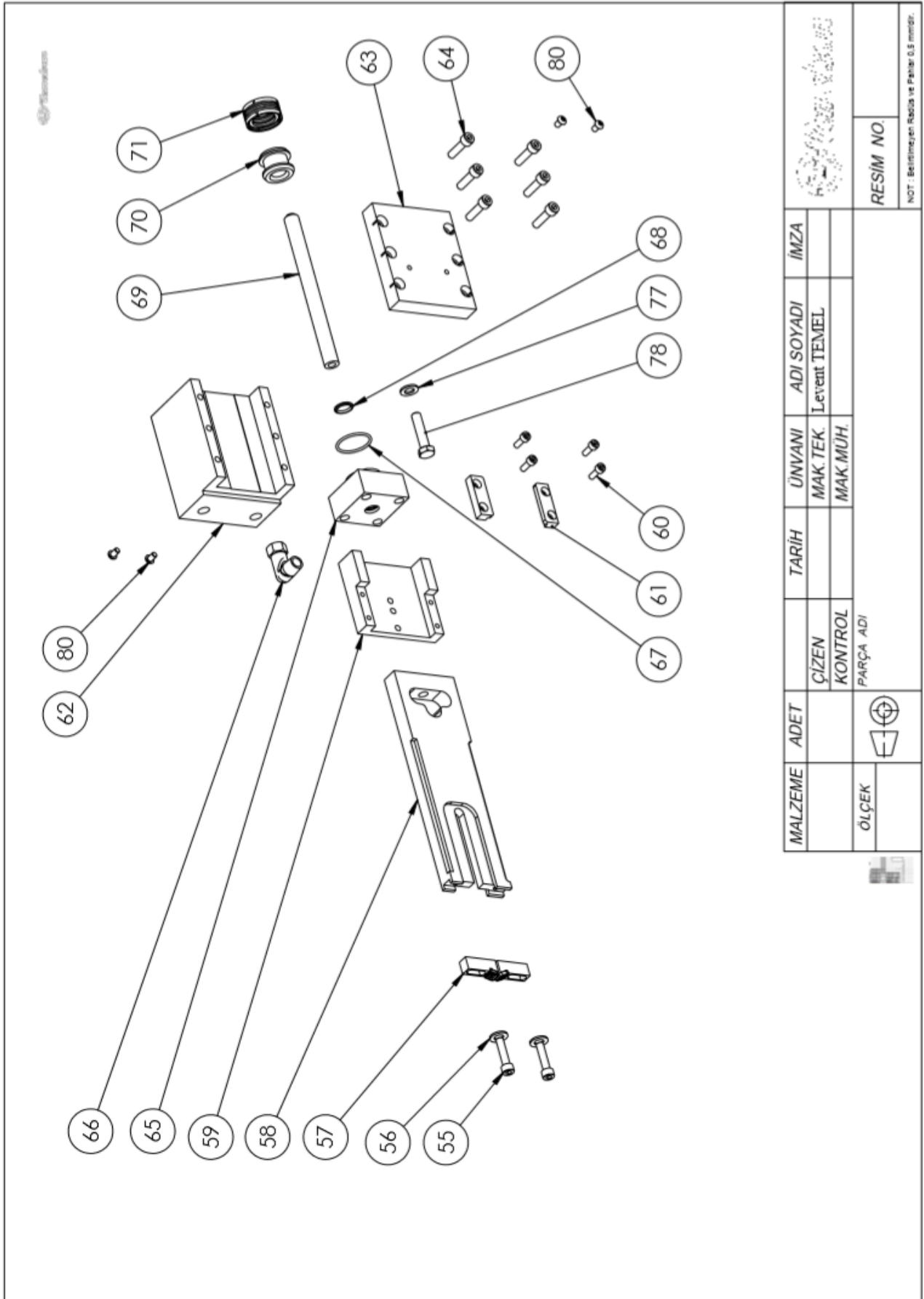

MALZEME	ADET	ÇİZEN	TARİH	UNVANI	ADI SOYADI	İMZA
		KONTROL		MAK. TEK.	Levent TEMEL	
ÖLÇEK		PARÇA ADI		MAK. MÜH.		
						RESİM NO.

NOT: Belirtilmeyen Ralolar ve Finitler 0.8 mm'dir.



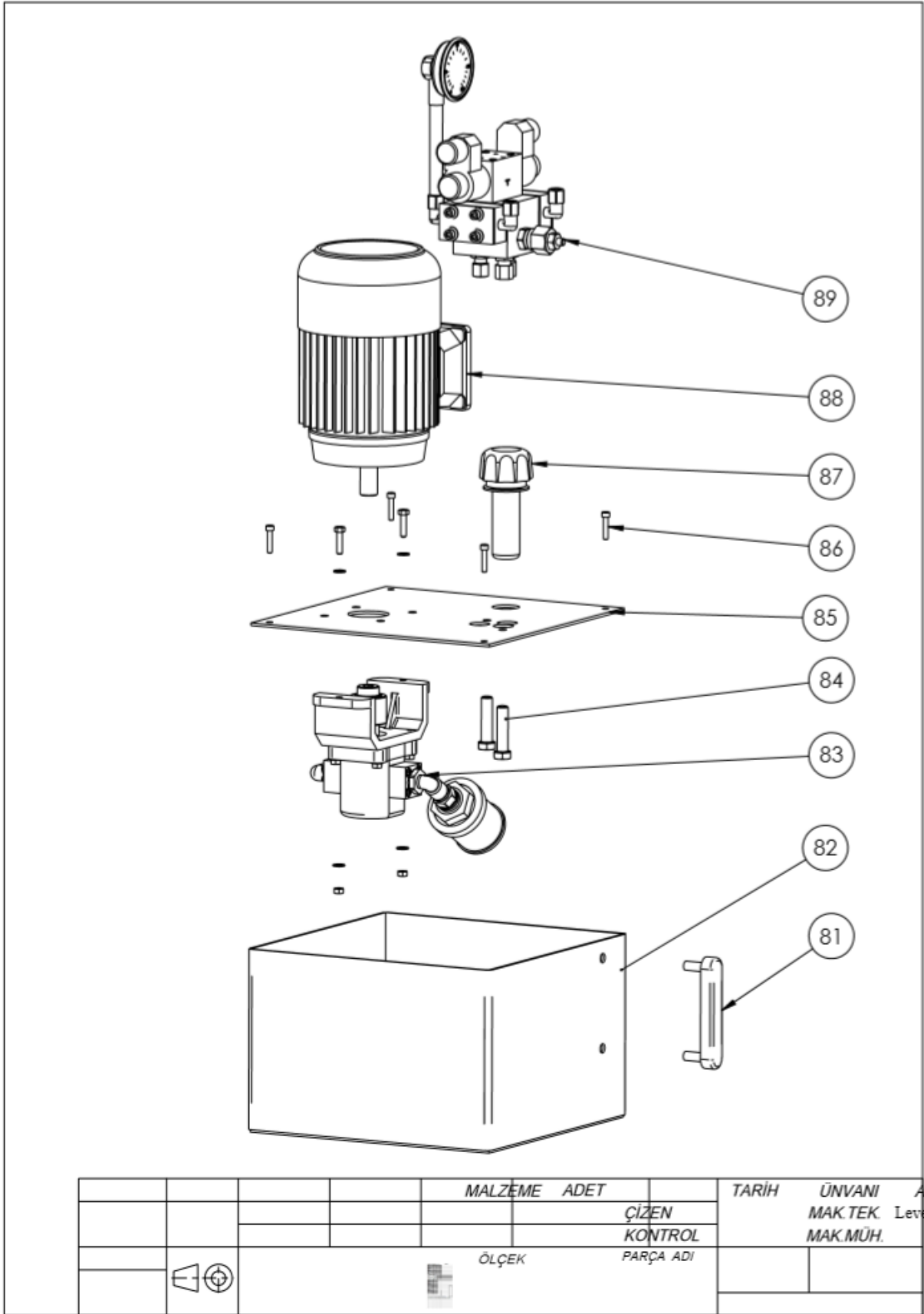

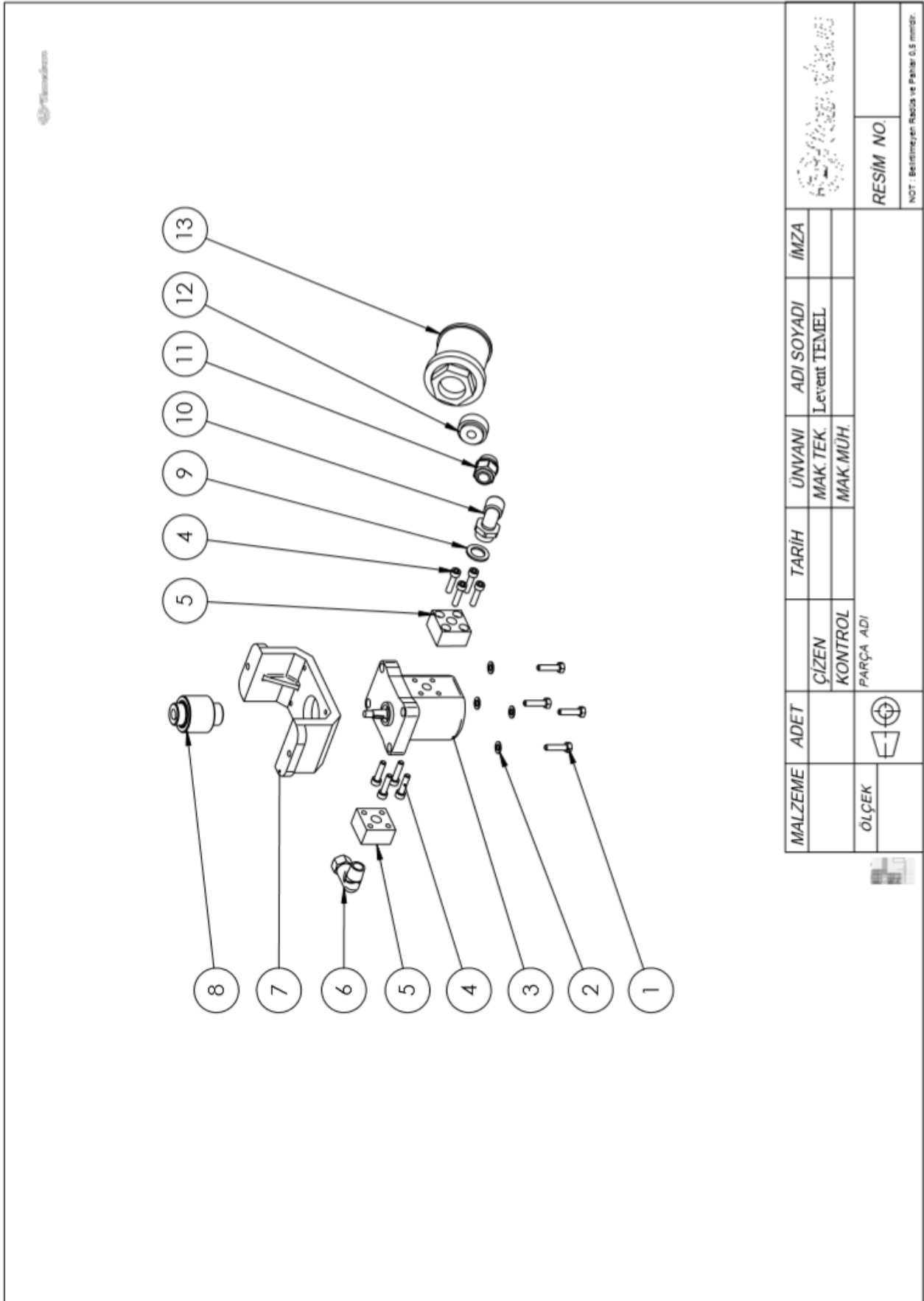

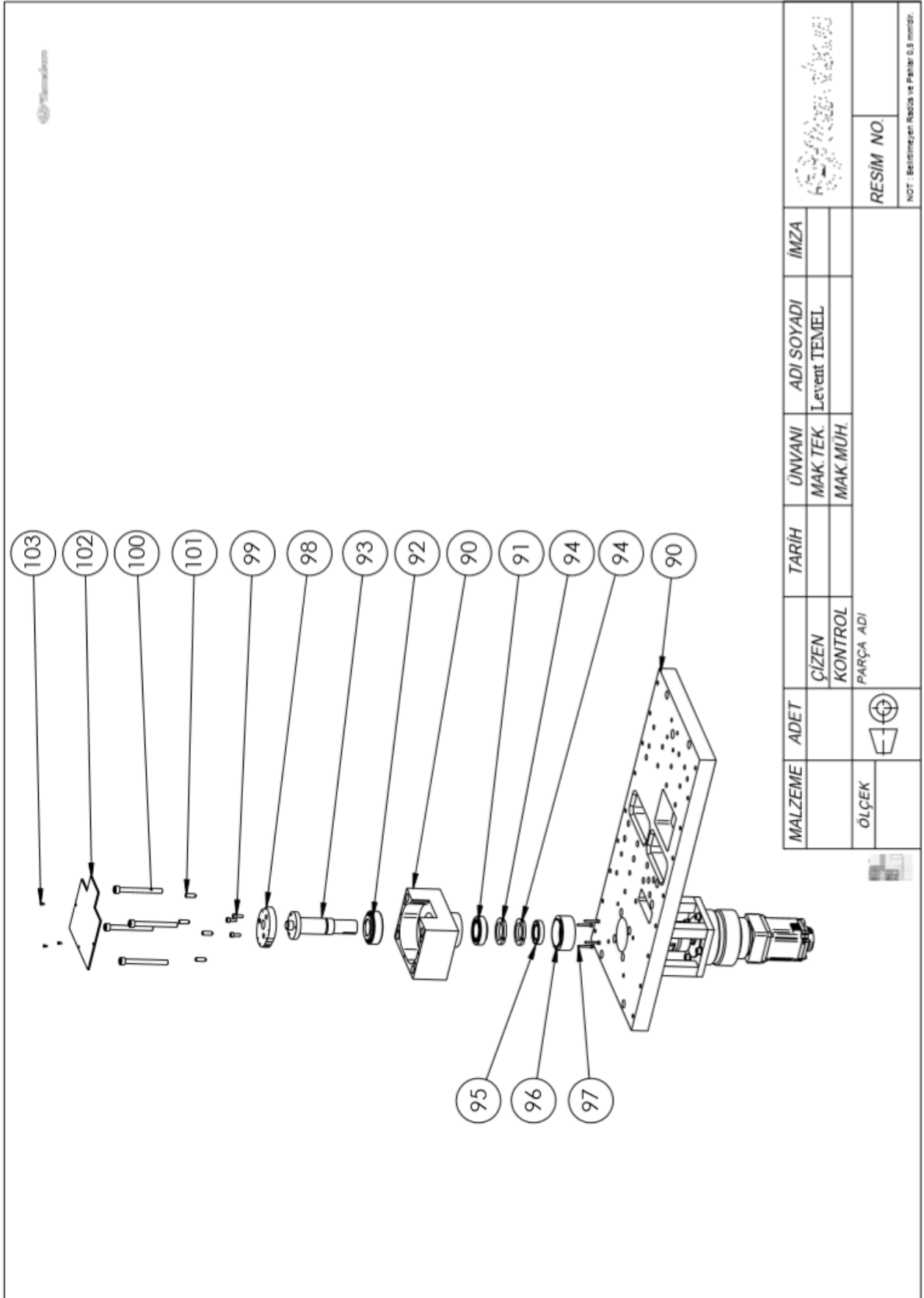

MALZEME	ADET	ÇİZEN	TARİH	UNVANI	ADI SOYADI	İMZA
		KONTROL		MAK. TEK.	Levent TEMEL	
ÖLÇEK		PARÇA ADI		MAK. MÜH.		
						RESİM NO.

NOT: Benimlemeden Rastis ve Pazarla 0.5 mm'dir.

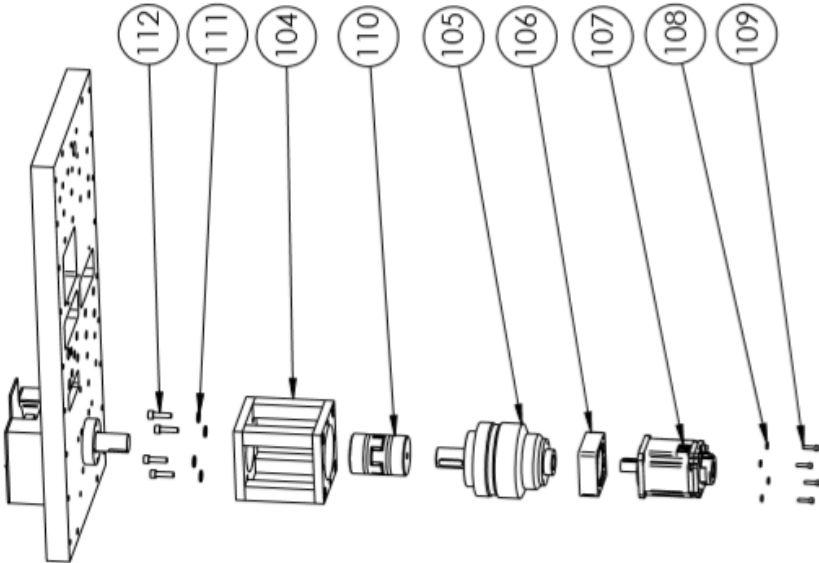

		ÇİZEN KONTROL PARÇA ADI	TARİH	ÜNVANI MAK TEK. MAK MUH.	ADI SOYADI Levent TEMEL	İMZA		RESİM NO



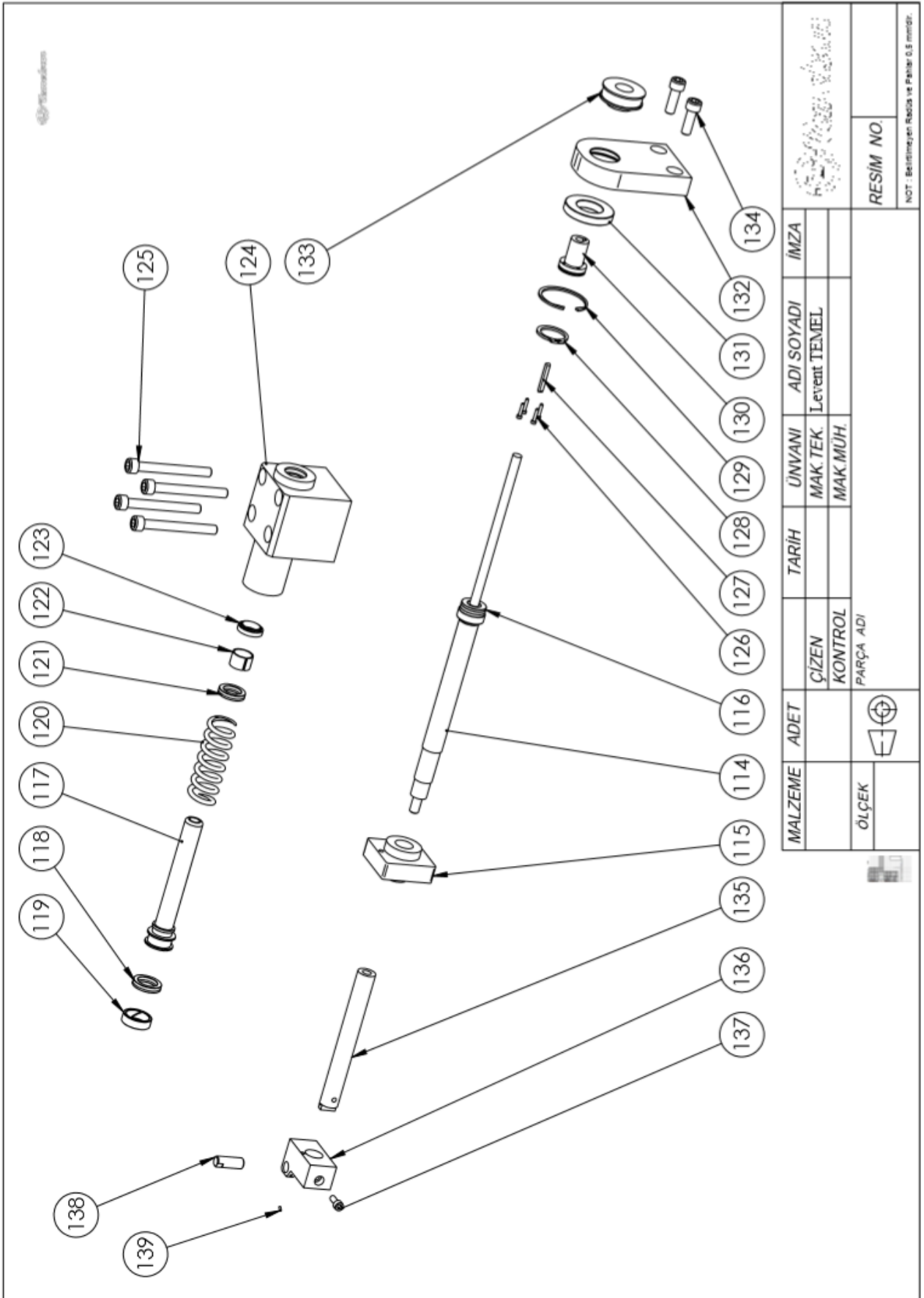

MALZEME	ADET	ÇİZEN	TARİH	ÜNVAHI	ADI SOYADI	İMZA
ÖLÇEK		KONTROL		MAK.TEK.	Levent TEMEL	
		PARÇA ADI		MAK.MÜH.		
						RESİM NO.

NOT : Belirtilen Rölös ve Parçalar 0,5 mm'dir.



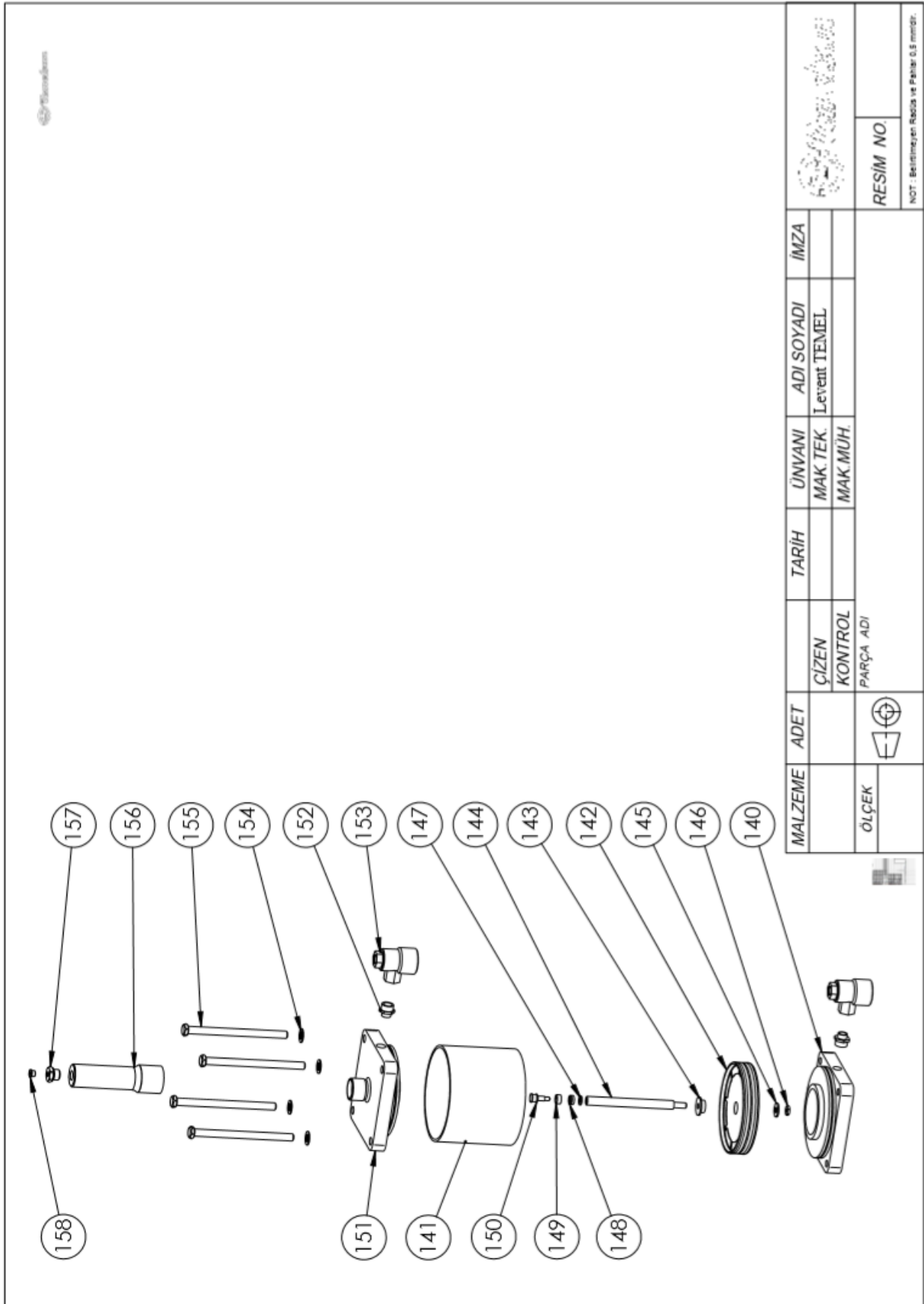



NO	PARÇA KODU	PARÇA ADI	ADET		
1	MA-YM-993	KN100 HBA TOUCH SOL AL KAPAK	1	SOL KAPAK MONTAJ	<b>A</b>
2	MA-YM-995	KN100 HBA TOUCH KAPAK ÜST TAKOZ	2		
3		M6X30	8		
4	MA-YM-994	KN100 HBA TOUCH SAĞ AL KAPAK	1	SAĞ KAPAK MONTAJ	<b>B</b>
5	EA-YM-042	PYROMETRE BAĞLANTI PİMİ	1	PİROMETRE	<b>D</b>
6	EA-YM-264	PYROMETRE AKIM KESME FİBER	1		
7		ALTUGEN HAVSABASLI M3X12	4		
8	EA-YM-039	PYROMETRE KUTUSU	1		
9	EA-YM-002	LED LAMBA 12VDC	1		
10	MA-MM-XXX	HBA NUMARATÖR	4	HBA NUMARATÖR	<b>C</b>
10--1	MA-HM-001	BAKALİT DIŞI ELCİK 50X10	1		
10--2		M10 SOMUN	1		
10--3	MA-YM-624	NUMARATÖR KORUMA SACI	1		
10--4	MA-HM-002	MEKANİK NUMARATÖR DA04	1		
10--5		İMBUS M4X40	2		
10--6	MA-YM-013	NUMARATÖR ANA GÖVDESİ	1		
10--7		M3X6 YILDIZBAŞ	4		
10--8	G-HM-043	RULMAN 6805	2		
10--9	MA-YM-015	HELİS MİLİ	1		
10--10	G-HM-045	SEKMAN 40 MM	1		
10--11	MA-YM-014	HELİS	1		
10--12	MA-YM-010	NUMARATÖR MERKEZLEME PİMİ	2		
10--13	MA-YM-012	NUMARATÖR SABİTLEYİCİ LEMASI	1		
10--14		İMBUS M5X25	1		
10--15	MA-YM-011	TESTERE DAYAMA ÇELİĞİ	1		
10--16		İMBUS M5X12	2		
11		İMBUS M4X10	2	PİROMETRE	<b>D</b>
12	EA-YM-086	ENDÜKTİF SENSÖR LE-17TSN08DPO	1		
13	PA-YM-001	PYROMETRE KAPAK AÇMA PİSTONU Q16X15 JIG	1		
14	EA-YM-041	PYROMETRE BAĞLANTI PARÇASI	1		
15	EA-YM-037	PYROMETRE KUTUSU KAPAĞI	1		
16		İMBUS M2X20	1		
17	G-HM-060	PYROMETRE İMPACTİGA310	1		
18		SEGMAN 6MM	2		
19	EA-YM-040	PYROMETRE KAPAK MENTEŞE PİMİ	1		
20		HAVSABAS ALYEN M5X12	2		

21	G-HM-021	BAKIR PUL 3/8	1	HD SIKMA 1	E	
22	HA-YM-025	NİPEL 3_8-1_4	1			
23		İMBUS M16X130	6			
24		SETSTKUR M8*25	1			
25	PA-YM-049	SIKMA GÖVDE SAĞ	1			
25--1		SIKMA GÖVDE SOL	1			
26		İMBUS M8X60	3			
27		SETSKUR M6X30	3			
28	PA-YM-050	GÖVDE KOVANI L105	1			
29		İMBUS M8X25	1			
30	G-HM-020	SIKMA PİSTON YAYLI PUL	1			
31	HA-YM-054	KEÇE ÜST YATAĞI	1			
32	HA-YM-008	SIKMA PİSTON ÜST KEÇE K75-45-50-14,8	1			
33	HA-YM-006	SIKMA PİSTON YAĞ KEÇESİ K40-50-35-11	1			
34	HA-YM-007	SIKMA PİSTON ALT KEÇE K75-45-50-9,5	1			
35	PA-YM-053	KEÇE ALT YATAĞI	1			
36	MA-YM-005	SIKMA PİSTON YAYLARI	1			
37	HA-YM-052	PİSTON SARI BURÇ	1			
38	MA-YM-051	SIKMA PİSTON ANA MİLİ	1			HD SIKMA 2
39	MA-YM-054	ÜST ÇENE ÜST PARÇA	1			
40	MA-HM-008	ARA PİM	1			
41		SETSKUR M6X10	1			
42	MA-YM-056	ÇENE PİM ELCİK	1			
43		İMBUS M8X25	5			
44		İMBUS M3X10	4			
45	MA-YM-848	ÇENE MONTAJ YAY LEMASI	2			
46	MA-YM-053	ÜST ÇENE ALT PARÇA	1			
47	MA-YM-551	MENEVİŞ AYAR MİLİ	1			
48	MA-YM-845	KN100-67 PABUÇ MERKEZLEME BURCU	2			
49	MA-YM-051	KN100 ÜST ÇENE PABUÇ	1			
50		İMBUS M8X20	2			
51		SETSKUR M5X10	1			
52		İMBUS M10X45	1			
53	MA-YM-055	PARALELLİK KAMASI	1			
54	MA-YM-485	MENEVİŞ AYAR YAYLARI 9X45	2			



55		İMBUS M8X30	2	DE BURRING UNIT 1	F	
56		M8 PUL	2			
57	PA-YM-061	DB ELMAS TUTUCULAR	2			
57--1	HA-YM-011	HB ELMAS	2			
57--2		TORX M4X6	2			
58	HA-YM-058	DB LAMA	1			
59	HA-YM-059	DB LAMA YATAĞI	1			
60		İMBUS M6X16	4			
61	HA-YM-060	DB LEMA YATAĞI KİRİŞLERİ	2			
62	HA-YM-057	DB YATAK	1			
63	HA-YM-056	DB YATAK KAPAĞI	1			
64		İMBUS M8X30	6			
65	HA-YM-044	DB PİSTON ÖN KAPAK	1			
66	HA-YM-032	DİRSEK 1_4 - 1_2	1			
67	HA-YM-009	ORİNG KO-35X2,5	2			
68	PA-YM-130	ORİNG 16X2,5	1			
69	HA-YM-062	DB PİSTON MİLİ	1			
70	HA-YM-073	HB PİSTON KEÇE YATAĞI	1			
71	HA-YM-010	DB PİSTON KEÇE TAKIMI K18 - 40X26X15X2,6	1			DEBURRING UNIT 2
72	HA-YM-037	HB PİSTON GÖVDE	1			
73	HA-YM-043	DB PİSTON ARKA KAPAK	1			
74	HA-YM-031	3_8-1_2 REKOR	1			
75	G-HM-023	PUL M10	4			
76	MA-YM-154	DB PİSTON SAPLAMASI	4			
77	G-HM-023	PUL M10	1			
78		ALTİGEN BAŞLI M10X45	1			
79	SK-YM-060	DB MUHAFAZA SACI	1			
80		ALYENBAŞ M6X10	4			

81	HA-YM-021	DB YAG SEVIYE GOSTERGESI	1	
82	HA-YM-038	DB DEPO	1	
83		8LT POMPA GRUBU	1	
83--1	G-HM-031	ALTIGENBAŞLI M6X25	4	
83--2	G-HM-005	M6 PUL	4	
83--3	HA-YM-098	YAĞ POMPASI 8LT	1	
83--4	G-HM-029	İMBUS M6X25	8	
83--5	HA-YM-013	POMPA BAĞLANTI ELEMANI	2	
83--6	HA-YM-028	REKOR 3_8	1	
83--7	HA-YM-041	POMPA BAĞLANTI FLANŞI	1	
83--8	HA-YM-099	DK24 KAPLİN	1	
83--9	G-HM-021	3_8 BAKIR PUL	2	
83--10	PA-YM-128	55116 12 3_8 DİRSEK	1	
83--11	PA-YM-129	500007 12 3_8 REKOR	1	
83--12	MA-YM-846	MAŞON	1	
83--13	HA-YM-014	YAĞ FİLTRESİ	1	
84		ALTIGENBAŞ M12X50	2	
84--1		PUL M12	2	
85	HA-YM-040	LB DEPOSU KAPAK	1	
86		İMBUS M5X25	4	
87	HA-YM-020	DB DEPOSU KAPAK	1	
88	MA-YM-089	ELEKTRİK MOTORU	1	
89		DB DEPO VALF GRUBU		
89--1	HA-YM-016	DB MANOMETRE 160 BAR	1	
89--2	HA-YM-068	MANOMETRE BORUSU	1	
89--3	HA-YM-031	1_8 - 8 DİRSEK	1	
89--4		İMBUS M5X50	4	
89--5	HA-YM-017	24V DC NG6 ÇİFT BOBİN AÇIK MERKEZ VALF	1	
89--6	HA-YM-067	SFERO DÖKÜM TAKOZ	1	
89--7	HA-YM-065	DB POMPA ARA FİBER İÇ	1	
89--8	HA-YM-135	AKIM KESME TAKOZU SOL	1	
89--9	HA-YM-066	AKIM KESME TAKOZU SAĞ	1	
89--10	HA-YM-036	AKIM KESME HORTUMU 14X12	8	
89--11	MA-YM-271	DB POMPA ARA FİBER DIŞ	2	
89--12	G-HM-239	M6 TEMELSAN PUL	8	
89--13		İMBUS M5X45	8	
89--14		dirsek		
89--15		basınc kontrol valfi		
89--16		rekorr		

DE BURRING DEPO

**G**

8LT DEPO GRUBU

90	MA-YM-020	KN100 HBA KAM YATAĞI	1	H
91	G-HM-050	KONİK RULMAN 32007	1	
92	G-HM-048	KONİK RULMAN 32207	1	
93		KN100 PLC KAM MİLİ	1	
94	G-HM-345	M40X1,5 RULMAN KİLİT SOMUNU	2	
95	MA-YM-001	KEÇE 30X52X10	1	
96	MA-YM-021	KN100 HBA KEÇE KAPAĞI	1	
97		İMBUS M4X30	4	
98	MA-YM-018	KN100 KAM	1	
99		İMBUS M6X16	3	
100		İMBUS M10X100	4	
101		SETSKUR M8X25	4	
102	MA-YM-016	KAM YATAK KAPAĞI	1	
103		YILDIZBAŞ M3X6	3	
104		ST120ÜST FLANŞ	1	
105		LIVLY PLANET REDÜKTÖR	1	
106		LIVLY REDÜKTÖR FLANŞI	1	
107		OMRON R88M SERVO	1	
108		M5 PUL	4	
109		İMBUS M5X20	4	
110		G28 KAPLİN	1	
111		M8 PUL	4	
112		İMBUS M8X30	4	
113	MA-YM-991	KN100 HBA ANA PLAKA	1	
114		KN100 PLC ÇENE ARALIK MİLİ	1	
115				
116		BUTERULMAN FAG 81102	1	
117	MA-YM-527	KN100-67 YAN BASKI PİSTON MİLİ	1	
118	MA-YM-003	KEÇE- K21- 22X32X6	1	
119	MA-YM-004	KEÇE K68- 26X32X10	1	
120	MA-HM-005	YAN BASKI YAYI	1	
121	MA-YM-002	KEÇE K21- 20X30X6	1	
122	MA-YM-006	TEFLON BURC 20X23X15	1	
123	HA-YM-005	TOZ KEÇESİ 20X28X5,7	1	
124	MA-YM-1016	KN100 HBA YAN BASKI PİSTON GÖVDESİ	1	
125		İMBUS M10X90	4	
126		İMBUS M3X20	4	
127		KAMA 35X4X4	1	
128		SEGMAN 28MM	1	
129		DIŞ SEGMAN 55MM	1	
130		RV PUL	1	
131		16006 RULMAN	1	
132		YAN BASKI RM KAPAK	1	
133		T28M5 KASNAK	1	
134		İMBUS M10X30	2	
135	MA-YM-849	SPINDLE MİL	1	
136	MA-YM-989	SPINDLE SARI	1	
137		İMBUS M6X16	1	
138	MA-YM-530	SPINDLE PİM	1	
139		SETSKUR M3X6	1	
				I

140	PA-YM-050	200 PİSTON ALT KAPAK	2		
141	PA-YM-053	200 PİSTON GÖVDE BORUSU	2		
142	PA-YM-011	KEÇE K25 - 200X27X35	2		
143	PA-YM-059	PİSTON KEÇE BURCU	3		
144	PA-YM-058	PNOMATİK PİSTON MİLİ	3		
145	G-HM-355	M12X30 ÖZEL PUL	3		
146	G-HM-227	M12 SOMUN	3		
147	PA-YM-047	PİSTON KEÇE DESTEK RİNGİ	3		
148	PA-YM-001	KEÇE 10X20X8	3		
149	PA-YM-076	KEÇE 20X16X9,4	3		
150	PA-YM-046	KEÇE MİLİ	3		
151	PA-YM-051	200 PİSTON ÜST KAPAK	2		
152	PA-YM-008	20X30 1_2-3_4 NİPEL	6		
153	PA-YM-081	FESTO 1_2 6822 ÇABUK EGZOS VALFİ	6		
154	G-HM-037	M16 PUL	12		
155	MA-YM-156	M16 200 LÜK PİSTON SAPLAMA	12		
156	HA-YM-045	HİDROLİK PİTON GÖVDESİ	3		
157	PA-YM-140	PİSTON ÇEKVALF NİPELİ	3		
158	PA-YM-025	30X15 1_4 KÖR TAPA	3		
159	PA-YM-049	160LIK PİSTON ALT KAPAK	1		
160	PA-YM-010	KEÇE K25- 160X27X31	1		
161	PA-YM-052	160 PİSTON GÖVDE BORUSU	1		
162	PA-YM-048	160 PİSTON ÜST KAPAK	1		
163				HAVA TANKI	<b>K</b>
164				PEDAL	<b>L</b>
165				TRAFO	<b>M</b>