



*Temelsan*<sup>®</sup>

## TAS 1001 RT HP 3 IN 1 GRINDING MACHINE USER MANUAL



Congratulation to your new TEMELSAN Griding Machine TAS 1001 RT HP 3 IN 1

## INDEX

BASIC INFORMATIONS .....	2
APPROPRIATE USE.....	2
WARRANTY AND LIABILITY .....	3
SAFETY .....	3
QUALIFIED PERSONNEL .....	3
PLANNING AND SET-UP .....	3
OPERATIONS .....	3
SAFETY DEVICES.....	3
AREAS OF USAGE .....	4
MAINTENANCE.....	4
ISSUES.....	4
SAFETY MEASURES RELATED WITH THE MACHINE .....	5
REQUIREMENTS OF WORKING PLACE .....	6
FIRST CONNECTIONS.....	6
POWER SUPPLY (WIRING DRAW SEE AT FOLLOWING PAGE).....	6
PRESS-AIR REQUIREMENTS .....	8
FIRST INSTALLATION AND ADJUSTMENTS .....	8
START-UP THE MACHINE.....	8
OPERATION STEPS.....	8
EQUIPMENTS .....	9
SERVICE THE GRINDER.....	10
CHANGING THE BACK EDGE GRINDING PAPER .....	10
CHANGING THE WELDING LINE GRINDER .....	10

## BASIC INFORMATIONS

This manual user guide is prepared to be useful in order to get familiar with the machine and the functions of the machine. By the help of this manual guide, the operator becomes a capable to use the machine in an optimal way in order to operationalize safely, ergonomically and properly.

This manual user guide allows the operators not to take risk, minimize the idle and repair time. It also helps to increase lifetime of the machine.

This manual user guide should be kept in a proper place and be accessible easily when needed. The local regulations included safety and environmental requirements must be followed in addition to the statements based on this manual user guide.

In case of an issue, complaint, request, demand on spare parts etc. please note the following information along with the below message

### **Concerning following Object:**

**Machine Model:** TAS 1001 RT HP 3 IN 1

**Mfg. year:** 2020

**Serial Number:** \_\_\_\_\_

## APPROPRIATE USE

The machine is designed to grind the all dimensions of steel and band saw blades.

In the event of using the machine rather than described in which case the machine would be out of warranty situation of Temelsan.

**Welding Line Grinding/** the machine is designed to make grinding on welding surfaces of steel and band saw blades. You have to select your grinding disk and replace on welding line grinder area.

**Teeth Grinding/** the machine is designed to have teeth grinding part on same body of machine. You have to select and replace your grinding bit.

**Back Edge Grinding/** the machine is designed to have back edge grinding part on same body of machine. You have to select and replace your grinding disk for back edge.

## **WARRANTY AND LIABILITY**

In the event of involving a personal injury or physical damages are not covered by the warranty if the following events occur as below.

- Using the machine for a purpose rather than intended
- Technically, improper installation, start-up operation or maintenance of the machine
- In the act of using the machine while any of safety equipment is a broken or protective device inappropriately running.
- Making constructional changes on running parameters.
- Insufficient control of abrasion parts
- Inappropriate repairs
- The catastrophic failures due to the action of foreign objects / Bodies and excessive force applied

## **SAFETY**

Below safety requirements must be applied without skipping anything and priority case to carry out.

## **QUALIFIED PERSONNEL**

Certain tasks must be carried out on the machine by a professional qualified personnel. Not third parties neither the children should be near the machine working area.

## **PLANNING AND SET-UP**

Planning, transportation, installation, programming, start-up, maintenance, repairs and other works must be done by qualified personnel. Authorized technician must check it also.

The following matters must be noted:

- Technical data and details concerning the permissible use of the machine and its accessories.
- General and specific local preparation and safety measures.
- Personal usage and the use of general safety equipment must be related the norms.
- Especially listed on this manual guide but specifically not listed in the operating instructions that has been explicitly forbidden. Such as a handicapped to use the machine is such cases it is necessary to contact the manufacturing company.

## **OPERATIONS**

Dangers hidden in disregards of safety regulations.

## **SAFETY DEVICES**

The machine is equipped with the safety devices corresponding to current state of the art. In the matter of safety equipment, the machine may not be disabled, removed, dismantled, damaged. It applies in particular to:

- Covers (Welding Line Grinder protection, Back Edge Grinder protection)
- Safety switches (Emergency Stop Button)
- Electrical and electronic fuses

## AREAS OF USAGE

The Grinding machine Temelsan TAS 1001 RT HP 3 IN 1 is used for any kind of steel bands and band saw blades or bi-metal or carbide tipped band saw blades.

The grinding capacity for Band Saw Blades is from minimum 6x0.65mm up to a maximum 54 x1.60mm. The machine is capable to grind all kinds of band saw blades which are called carbon, wood, bi-metal, CT Work on the electrical power supply is only to be done by professional electrician.

The machine need to be assembled on floor.

The machine can be set-up by the customer's own staff if officially approved by Temelsan.

Please read the following sections thoroughly and carefully before the initial start-up and ensure that you clearly understand it.

## MAINTENANCE

In order to insure a safe operation on the machine and prevent accidents, the job listed in the section "Servicing" must be carried out regularly. If the owner of machine is not in a position to do that also must be arranged by an authorized service agent.

## ISSUES

The machine must be switched off at once in case of any problem occurs during the operation and then locked for not being restarted accidentally by an unauthorized person.

The machine must be switched off in this case.

- Unusual sounds, vibrations, smells
- Increased temperatures or power consumption



### WARNING!

Only suitably qualified personnel must service the machine!



### EMERGENCY

**ATTENTION!**

Note the following at emergent cases (fire, explosions, breakage):

- Cut the machine off from the mains power supply at an external main switch or external fuses
- Switch off the compressed air supply
- Use the fire extinguishers of a suitable type to deal with the fire

**SAFETY MEASURED RELATED WITH THE MACHINE****WEAR PROTECTIVE GLASSES!**

Grinding beads produced during grinding work could damage your eyes.

**WEAR GLOVES!**

The sharp edges of the blades can cause hand injuries.

**DANGER OF FIRE!**

Easily inflammable materials could be set alight if they come in to contact with welding sparks

**SWITCH OFF THE MACHINE!**

Cut off machine from the main supply before carrying out setting-up maintenance and servicing work on the machine.

**ATTENTION!**

It's dangerous when contacting parts of the power supply, control and transformer.

**IN CASE OF EMERGENCY;**

Push the emergency stop button.

The emergency stop button is to use by emergency issues only!

## REQUIREMENTS OF WORKING PLACE

- Flat and smooth ground
- Required big enough area around the machine
- Environmental conditions
- The client is obliged to local electrical distributor notified technical requirements

## FIRST CONNECTIONS

### POWER SUPPLY (Wiring draw see at following page)



**Make sure that the main switch of the machine is on OFF position and prevent to be turned on by an accident.**

A qualified electrician must do the connection.

The input voltage (standard norm) is 380V AC (3 Phase + Neutral + Ground) 50Hz.

The recommended power supply cable is 4x2,5mm

RST marks for phase connections, N mark is Notr Connection and Yellow Green cable is for World connection.

**The Diameter of each wire for power supply it's very important, please use the chart by selecting the Machine Type**

**Do not switch ON the machine before the all setup instruction is read and work performed**



**ATTENTION!**

Pay special attention to protect yourself from the energized cables moreover the control panel while operating the machine. Keep closed the cover of electrical control panel and do not forget to take out all the foreign objects in the cabinet which might cause short circuit.



**WARNING!**

- Working on the electrical power supply has to be only done by professional electrician.
- The electrical equipment of the machine must be checked regularly
- Always keep the switching cabinet locked. Access is only permitted to authorized personnel with the key or special tool.



- Remove at once any loose or worn cables
- If it is essential to work on parts carrying a current there must be a second person present to turn off the main switch in case of an emergency
- The customer is required to comply with the technical conditions and requirements of the relevant electrical power supply company

		KABLO / CABLE							
MAKİNE MODELİ MACHINE TYPE	TRAFO KVA	ŞEBEKE GERİLİMİ LINE VOLTAGE	SİGORTA GEÇİKMELİ FUSE SLUGGISH TYPE	KABLO MODELİ CABLE TYPE	KABLO UZUNLUK CABLE LENGTH	NOMİNAL KESİT NOMİNAL CROSS SECTION	DIŞ ÇAP OVERALL DIAMETER	İLETKEN TEL SAYISI VE ÇAP NUMBER OF CONDUCTING WIRE	
		VOLT AC	AMPER		METER	mm <sup>2</sup>	mm	mm	
KN41 HBS	4.5 KVA	400 VAC	50	TTR	< 5	5x10	21	6	
KN67 HBS	12 KVA	400 VAC	63	NY	< 5	3x16 + 10 +10	23	7x1,7	
KN67 HBA	40 KVA	400 VAC	63	NY	< 20	3x25 + 16 +16	25	7x2	
KN100 HBA	63 KVA	400 VAC	63	NY	< 50	3x35 + 16 +16	32	7x2,4	

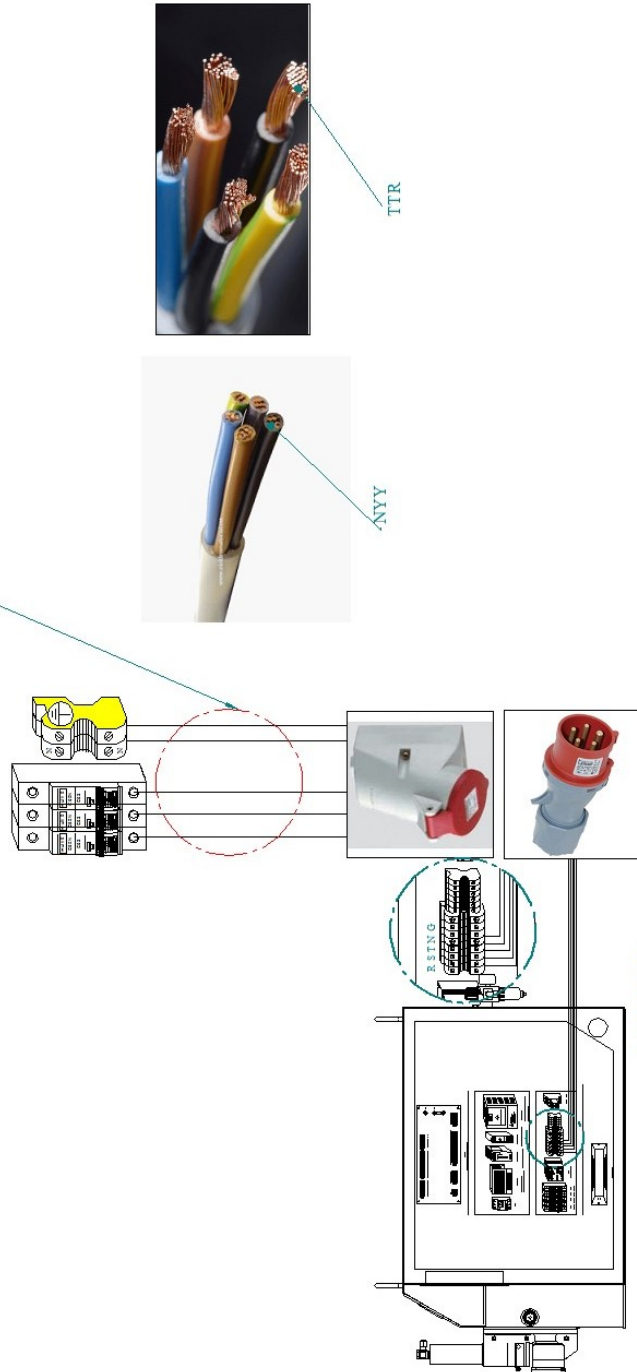
MAX 5 METER  
NY 3X16+10+10  
(KN41 HBS TTR 5X10 )



## PRESS-AIR REQUIREMENTS

The machine needs dry and clean air pressure, which needs 6-8 bars. The reservoir capacity of the air compressor should be at least 150 liters.

### Air Supply Check

Main Air Supply minimum 6 maximum 8 Bar

The compressor should be adjusted as starting to fill the air by 6 Bar and stop to fill by 8 Bar if Clamping Pressure does not reach the enough capacity, the main air pressure is too low never adjust the main Air pressure over 8 Bar. Factory adjustment is 9,5 Bar The Tube size for Air Pressure supply is minimum 12x10 mm.

## FIRST INSTALLATION AND ADJUSTMENTS

Authorized professionals, who must read this user guide, must do first installation and adjustments. In case of questions, is an immediately contact with manufacturer/supplier required.

## START-UP THE MACHINE

1. Turn the main power switch to ON
2. Check and unlock the Emergency Stop Button (to unlock turn on Button to left side)
3. Push the Green Start Button for Ready to Use

## OPERATION STEPS

- 1- Push the **“GREEN START BUTTON”**
- 2- Open the clamping jaws by pushing the **“CLAMPING JAWS OPEN-CLOSE PEDAL”**
- 3- Replace your Band Saw between the Jaws
- 4- Close the clamping jaws by pushing the **“CLAMPING JAWS OPEN-CLOSE PEDAL”**
- 5- Set the distance of Grinding Disk from saw surface by using the **“UPPER-LOWER DISTANCE ADJUSTMENT HANDLE”**
- 6- Rotate the **“WELDING LINE GRINDER”** on band saw surface, while rotate the grinder use the **“UPPER-LOWER DISTANCE ADJUSTMENT HANDLE”**
- 7- Repeat the steps 2,3,4,5 AND 6 to another side of band saw
- 8- Use the **“TEETH GRINDER”** to make teeth of saw
- 9- Open the clamping jaws by pushing the **“CLAMPING JAWS OPEN-CLOSE PEDAL”**
- 10- Start the Back Edge Grinder by pushing the **“BACK EDGE GRINDER START PEDAL”**
- 11- Push the **“RED STOP BUTTON”** to finish operation.

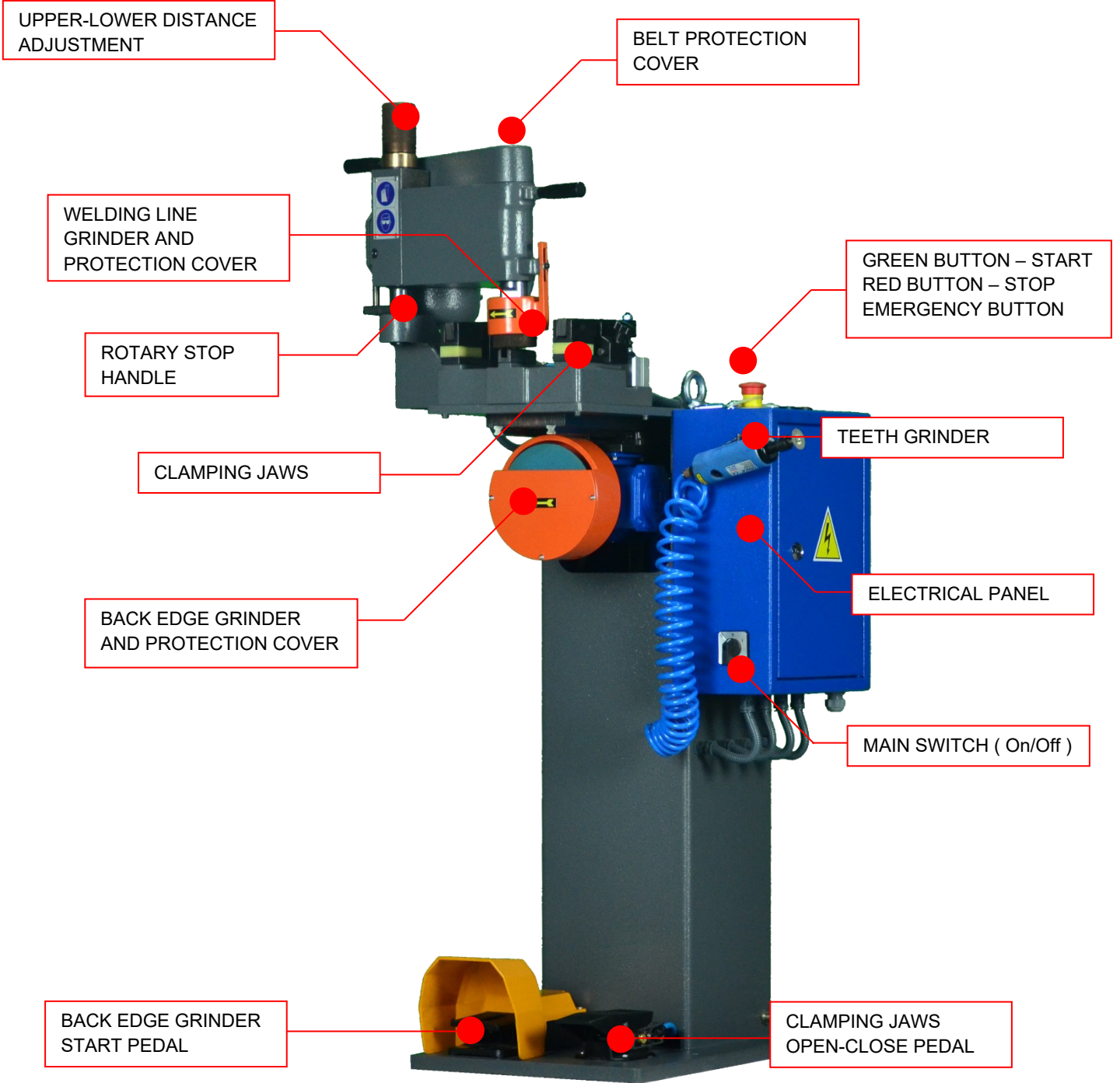
**EQUIPMENTS**

## SERVICE THE GRINDER

### 1- CHANGING THE BACK EDGE GRINDING PAPER

Remove those three screws and open the protection cover then change the Grinding paper and replace the cover back.

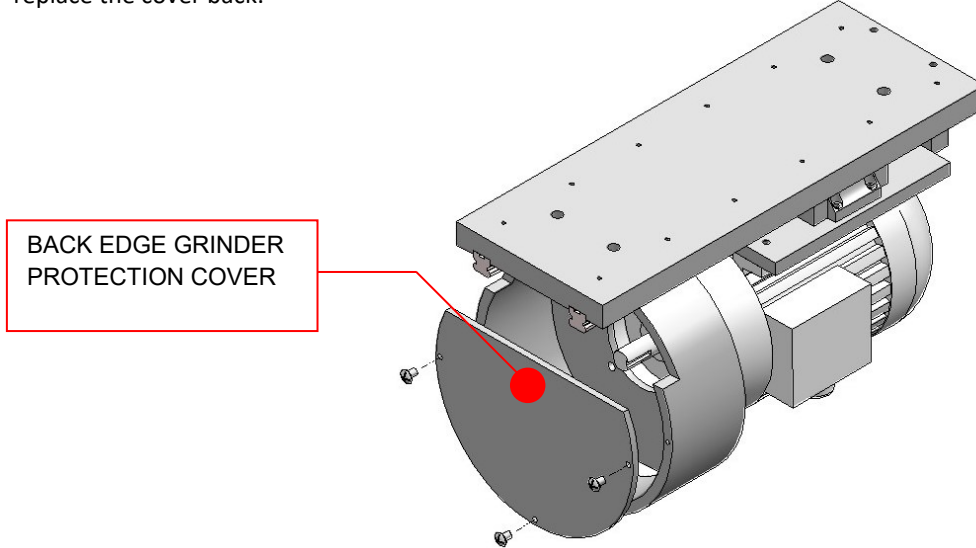

### 2- CHANGING THE WELDING LINE GRINDER

While using the machine grinder will be smaller and its

- First will need to move protection cover of Welding Line Grinder.
- You can adjust Protection Cover by the size of Grinding Disk to unscrew those two screws.
- Push the Grinder on front and screw the Rotary Stop Handle from left side on Clockwise
- Change the Grinding Disk
- Unscrew Handle on Counterclockwise

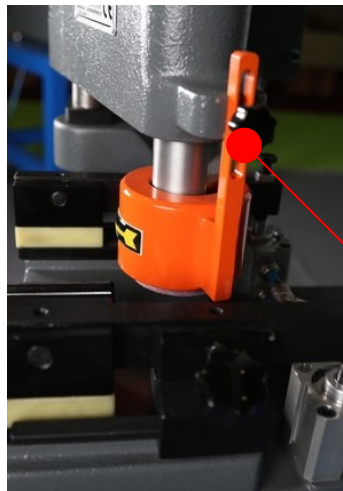

PROTECTION COVER  
LEVEL ADJUSTMENT  
SCREWS

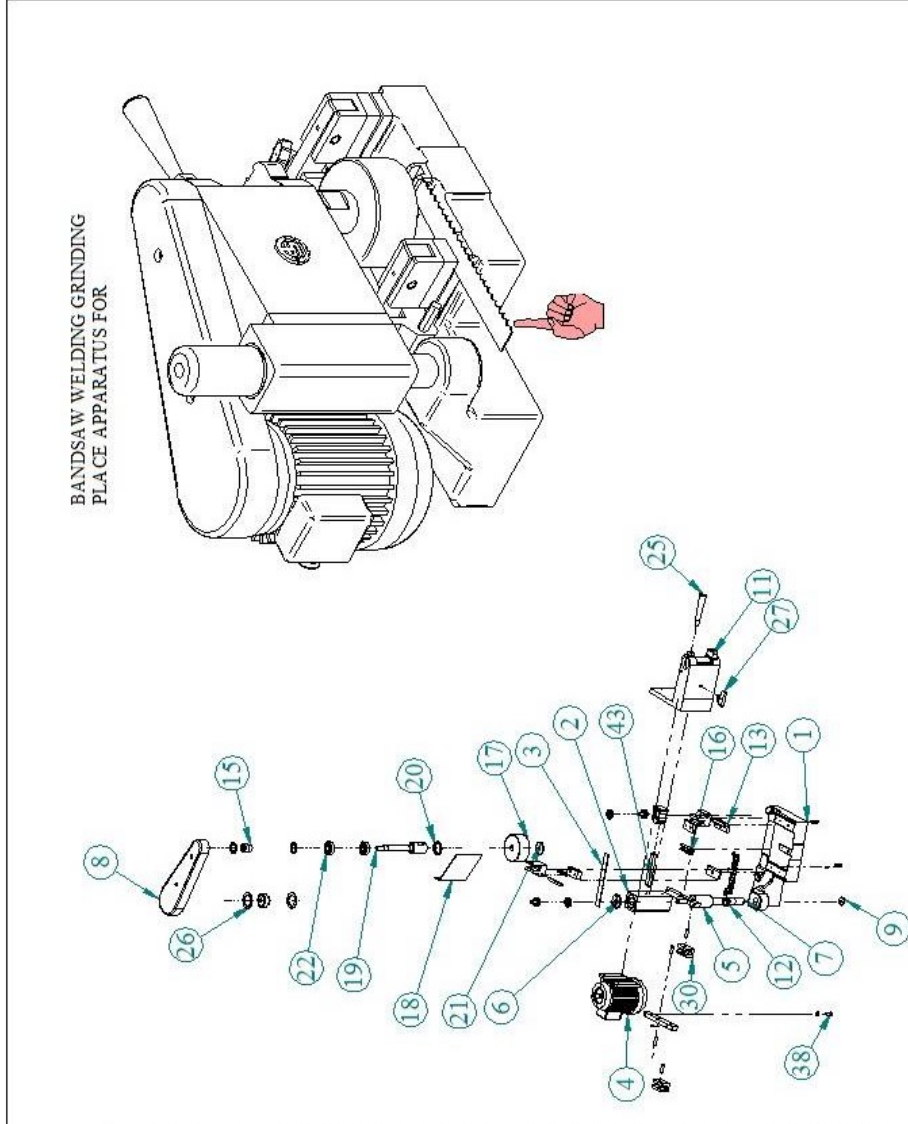

BANDSAW WELDING GRINDING  
PLACE APPARATUS FOR



RESİM NO. \_\_\_\_\_

NOT: Belirtilmeyen Resimlere ve Parçalara 0.8 mm'dir.

SIRA NO	ADET	PARÇA ADI
1	1	ALT-ANA-GOVIDE.par
2	1	PR3.par
3	1	TESTERE 1.par
4	1	M018FAY.par
5	1	PR25.par
6	1	Pr26.Par
7	1	MIL01.par
8	1	PR5.par
9	1	PR18PAR.PAR
10	1	BI51103.par
11	1	PR4.par
12	1	ARMA333.par
13	2	PR8 PAR
14	1	ARMAYAZIS-KUCUK.par
15	1	TRINKA SKNAK1.par
16	1	PR6 PAR
17	1	Tas10001.Par
18	1	SALRE TMHFZ.psm
19	1	PR15.par
20	1	Tz.40.48.par
21	1	PR18.par
22	2	6204.Par
23	2	TRINSA C1.par
24	1	TRINKA SKNAK2.par
25	1	Part6.par
26	2	TRINSA C2.par
27	1	SALTERK.OL.par
28	2	Pr14.par
29	2	PR10.par
30	2	PR9.par
31	2	Pr11.par
32	4	Part4.par
33	2	PR13.PAR
34	2	BK 32x15xM 6.par
35	2	TAS-9x45-Y estl.par
36	2	STM5X10.PAR
37	1	Sm8.par
38	1	Abm8x20.Par
39	2	Hbal5x15.par
40	2	PISHV3210.par
41	2	PISHV3210MIL.par
42	2	PISHV3210SR.par
43	1	Hvav01.Par
	62	

MALZEME	ADET	ÇİZEN	TARİH	ÜNVANI	ADİ SOYADI	İMZA
			21.01.2001	MAK.TEK.	Mehmet TEMEL	
		KONTROL	21.01.2001	MAK.MÜH.		
ÖLÇEK		PARÇA ADI	BANDSAW WELDING PLACE			